

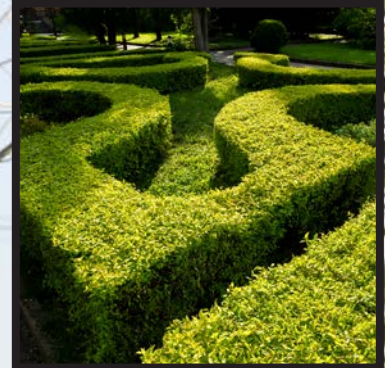

# MARUYAMA<sup>®</sup>

## OUTDOOR POWER EQUIPMENT CATALOG



**MORE  
POWER  
FOR THE PROS!**

VISIT [MARUYAMA-US.COM](http://MARUYAMA-US.COM)

OR SCAN THE  
CODE FOR MORE:



Gear Box features and Icon Descriptions.....	4	Piston Pumps.....	24-25
CER Engine Features .....	5	Piston Pump Engine Combos .....	26
BL70 Product Highlight and Features .....	6-7	Skid Sprayers .....	27-29
Brush Cutters and Trimmers .....	8-9	Portable Sprayers .....	30-31
Multi-Cutters .....	10-11	Backpack Misters And Duster .....	32-33
Hover Mower .....	12	Battery Sprayer.....	34
Pole Pruners .....	13	Manual Spreader and Duster	
Hedge Trimmers .....	14-16	Trenching Tool and Water Pump .....	35
Big M Pro-Scape.....	17	Sprayer Accessories .....	36-37
Edgers .....	18	Accessories .....	38-39
Landscape Blade .....	19	Product Specifications .....	40-42
Blowers.....	20-21	Blue Ultra Shield.....	43
Chainsaws .....	22-23		



**MORE  
POWER  
FOR  
THE PROS!**

# WELCOME

We proudly celebrate **Maruyama's** 129th anniversary as an industry-changing manufacturing company.

**Maruyama** began in Japan, as a family business manufacturing fire extinguishers in 1895. The Uchiyama family then started to manufacture manual sprayers in 1918. With their development of the power sprayer in 1933, **Maruyama** played an important role in disaster control and prevention. They also contributed to food production in the agricultural industry during the post-depression years.

For over a century, **Maruyama** has become a world leading manufacturer of disaster relief and prevention equipment, creating high quality pressure industrial pumps, sprayers and commercial-grade 2-cycle landscape equipment. **Maruyama US** is now claiming a part of the pest control industry with newly designed, versatile, high-capacity skid sprayers.

**Maruyama** endeavors to meet and exceed life's obstacles with our commercial grade power equipment and sprayers.



**MASANOBU OGASHIRA**  
Chairman

**TAKAHARU UCHIYAMA**  
President

# HEAVY DUTY GEAR BOX FEATURES

- 1. THREADED CLUTCH SHAFT**  
The solid inner driveshaft is threaded at the clutch end to reduce vibration
- 2. DUAL ANTI-VIBRATION CLUTCH HOUSING**  
Helps reduce operator fatigue and provides a more comfortable working experience
- 3. BRONZE BUSHINGS**  
Five self-lubricating dampened bushings to fully support the inner shaft for smooth operation and greater structural integrity
- 4. POLISHED SOLID STEEL SHAFT**  
Solid steel shaft for exceptional durability and completely protected by a lifetime warranty
- 5. EXTRUDED ALUMINUM SHAFT**  
One-piece, seamless aluminum outer shaft for added strength and durability
- 6. HEAVY DUTY GEARBOX - 4-BEARING SUPPORTED GEARBOX**  
4-bearings support for low vibration and ability to absorb higher shock loads
- 7. HELICAL CUT CHROME MOLY PINION GEARS**  
Extremely tough materials for long time performance and corrosion resistance

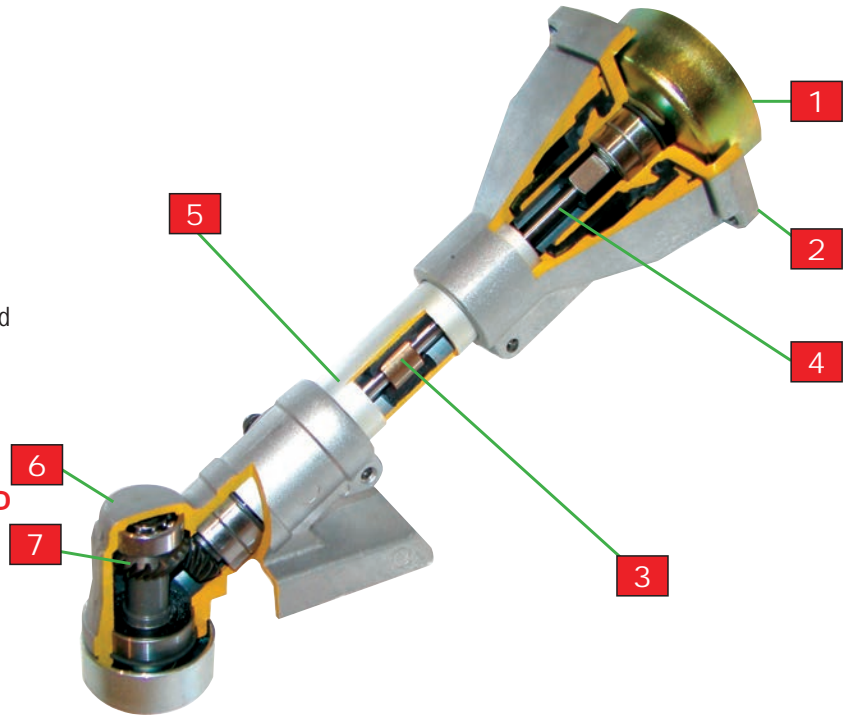

## FEATURE ICON DESCRIPTIONS



### DISPLACEMENT (CC)

Engine displacement refers to the total volumetric engine size measured in Cubic Centimeters, or "CC's", i.e. "42cc"



### DRY WEIGHT

The weight of a complete unit without oil, gasoline, water, or chemical mix. The dry weight is measured after all components to operate the unit have been installed.



### FUEL TANK

The fuel tank is a container to safely store fuel supply until precisely metered into the engine through the carburetor.



### EASY START

Refers to a dual spring recoil system, developed by Maruyama, that significantly decreases the physical effort required to pull start the engine.



### ASSISTED START

Maruyama assisted starter system eliminates the need for a strong pull to start the unit. Short pulls that require little effort will start the unit. Available in selected units.



### HARDENED STEEL

Every Maruyama hedge trimmer features induction hardened steel blades with dual-reciprocating movement for maximum sheering force.



### ADJUSTABLE THROTTLE

Adjustable maximum throttle control for consistently regulating operational cutting speed.

- Waterproof kill switch button
- Cold-start feature that helps the engine start in colder weather and high altitude



## CER ENGINE FEATURES

Maruyama CER Engines are powerful and friendly with the environment. Maruyama utilizes the latest clean 2-cycle engine technology that not only meets but exceeds today's strict emission regulations around the world. Their environmental friendliness and power will exceed your expectations. Get to know Maruyama technology.

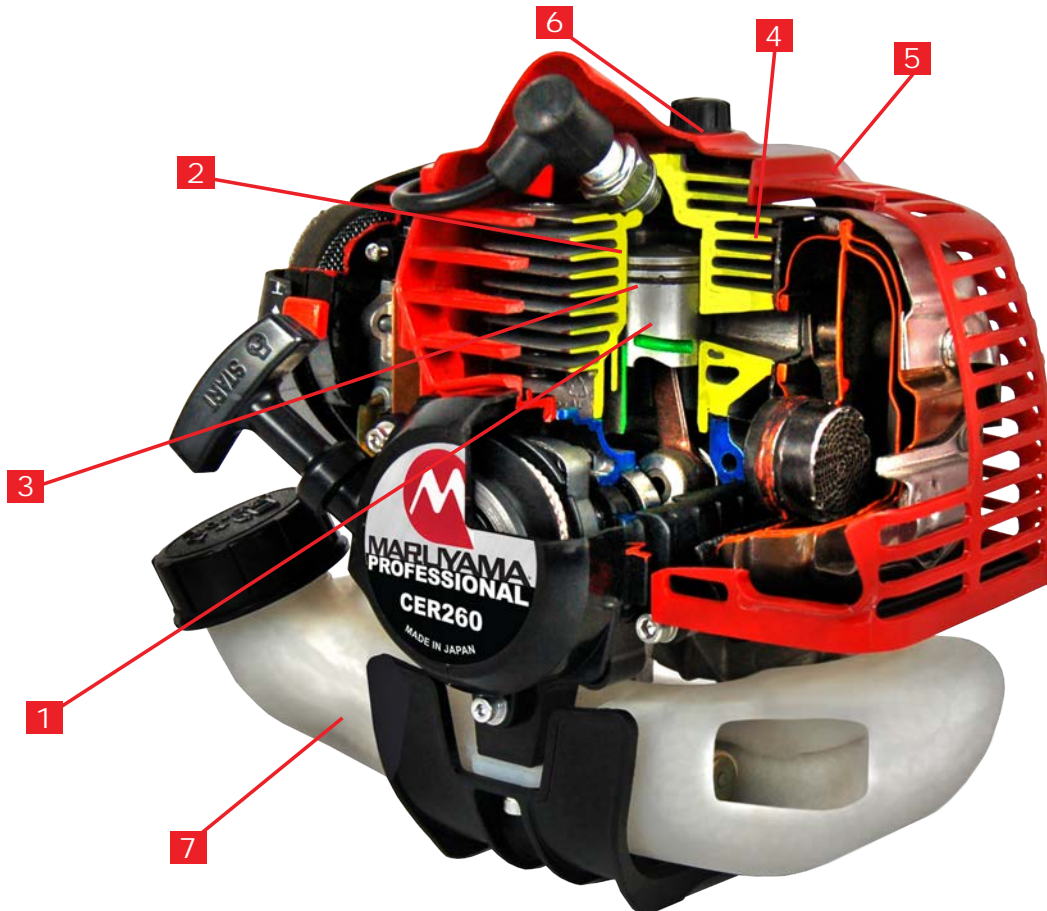

### 1. GROOVED PISTON

The re-circulatory groove is key to the patented HERE (High Efficiency Recirculating Engine) low emission system

### 2. HARD CHROME PLATED CYLINDER

Increases the life to the cylinder and improves performance

### 3. DUAL PISTON RINGS

Increased engine compression which translates into high torque and balance for power and performance

### 4. EXTENDED COOLING FINS

Improved cooling system for extended commercial usage

### 5. ELECTRONIC IGNITION SYSTEM

CDI ignition coil allows for a superior performance

### 6. QUICK RELEASE ENGINE COVER

One bolt design to remove cover makes service faster and easier

### 7. LARGE TRANSLUCENT FUEL TANK

Longer running time between fill-ups translates into increased profits for the commercial landscaper



**MID-SIZED BACKPACK BLOWER  
BL70**



# MID-SIZED BACKPACK BLOWER

## BL70 FEATURES

Heavy-Duty  
Two-Stage Air Filter

Wide Carry &  
Transportation Handle

Adjustable Throttle Trigger

Low Noise  
Muffler

Light Weight  
Gravity Tubing

Assisted  
Start  
System

Anti-Vibration Metal Spring

Large 71 oz  
Fuel Tank

Wide Starting Step

Fuel Line Cover



**MORE  
POWER  
FOR THE PROS!**



# BRUSH CUTTERS AND TRIMMERS

## LOOP HANDLE TRIMMERS

JAPANESE 2-STROKE ENGINE  
TECHNOLOGY

**LIFETIME  
WARRANTY**  
ON SOLID STEEL  
DRIVESHAFT



### B230C

22.5 cc / CER230

10.5 lb

16.9 oz



# 364848



### B230L

22.5 cc / CER230

11.3 lb

16.9 oz



# 364849



### B270L

25.4 cc / CER260

11.7 lb

20.3 oz



# 364850



### B300L

30.1 cc / CER300

11.5 lb

20.3 oz



# 364853



### B420L

41.5 cc / CER420

16.4 lb

33.8 oz



# 364857

**MARLYAMA  
TURBO**

### TURBO TRIMMERS

are your best choice for cutting dense, wet grasses or thick ground covers - as well as day to day lawn trimming.

The 1.9 : 1 gear reduction increases torque resulting in greater power, without making the engine work harder.

**TURBOS DO IT ALL!!**



**1.9 : 1  
Gear  
Reduction**



### B270L TURBO

25.4 cc / CER260

12.1 lb

20.3 oz



# 364851



### B300L TURBO

30.1 cc / CER300

12.2 lb

20.3 oz



# 364854

Displacement (cc)
 Dry Weight (lb)
 Fuel Tank Capacity (oz)
 Adjust. Throttle w/Anti-Vibration Grip
 Tank Retention Ring
 Ergonomic Pull
 Easy Start





## Maruyama Trimmers and Brush-Cutters

are unique for what they do and how they do it. They are a rugged, dependable, day in and day out machines. Maruyama designs tools for good old-fashioned, roll up your sleeves, professional-grade use.



### BRUSH CUTTER

OFFSET  
HANDLEBAR



#### B420

- 41.5 cc / CER420
- 17.7 lb
- 33.8 oz
- 
- 8mm shaft - solid steel
- # 364856



**ERGONOMIC DESIGN BULL HORN HANDLE**  
Our ergonomic-design handle grip offers superior comfort and excellent balance for the user.

**THREADED CLUTCH SHAFT**  
The solid steel inner drive-shaft is threaded at the clutch end, which eliminates vibration

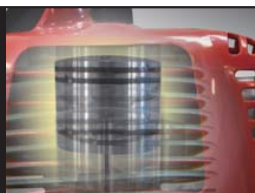

**HIGH TORQUE ENGINE**  
Engineered with high compression ratio resulting in higher torque and power. CARB / EPA compliant.

**EASY START**  
The easy start system has incorporated the best starting, fast and easy start.

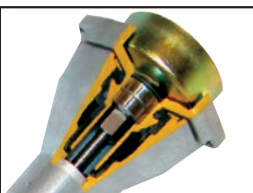

**DUAL ANTI-VIBRATION**  
Helps reduce operator fatigue and provides a more comfortable working experience.



# MULTI-CUTTERS



MULTI-CUTTERS SOLD AS POWER HEAD ONLY



## M270QC



25.4 cc / CER260

10.4 lb

20.3 oz



# 364858



## M300QC



30.1 cc / CER300

10.1 lb

20.3 oz



# 364859

## BACKPACK MULTI-CUTTERS

### M420BK-QC



41.5 cc / CER420

23.4 lb

33.8 oz



# 364860



- Iron 5-yr commercial warranty
- Ergonomically designed frame
- Fast & easy changes with the Quick-Connect™ System



Displacement (cc)
 Dry Weight (lb)
 Fuel Tank Capacity (oz)
 Adjust. Throttle w/Anti-Vibration Grip
 Tank Retention Ring
 Ergonomic Pull
 Easy Start



# QUICK CONNECT™ MULTI-CUTTER ATTACHMENTS

## QUICK CONNECT™



### QC-S TRIMMER

Ideal for trimming along fences, walls, around flower beds and everyday landscaping.

#364527



### QC-ST TURBO TRIMMER

Ideal for trimming along fences, walls, around flower beds and everyday landscaping. Featuring a powerful Turbo reduction gearbox 1.92:1

#364528



### QC-HT

20 in.  
HEDGE TRIMMER  
Perfect for shaping long and wide hedges. 20" blade, fix head

#364523



### QC-HTS

18 in.  
HEDGE TRIMMER  
Perfect for shaping long and wide hedges. 18" blade, 135° articulating head

#364533

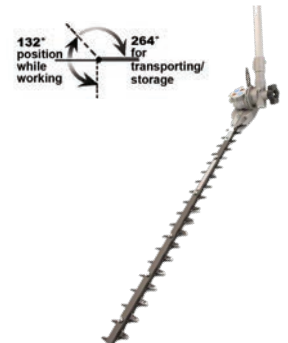

### QC-HTR

24 in.  
HEDGE TRIMMER  
Perfect for shaping long and wide hedges. 24" blade, 264° articulating head

#364532



### QC-PL LONG PRUNER

Cuts high branches with ease, shaft length 59", 10" blade

#365014



### QC-T TILLER/CULTIVATOR

Ideal for turning flower bed soil and aerating

#364526



### QC-LB LANDSCAPE BLADE (V6)

Heavy-duty gear-case, 360° Counter-rotating blades, 7mm solid steel driveshaft

#391431



### QC-ES STRAIGHT EDGER

For that perfect manicured edge along the sidewalk, driveways and patios. Adjustable blade height

#364525



### QC-E EDGER

For that perfect manicure edge along the sidewalk, driveways and patios. Curve shaft, adjustable blade height

#364524



# HOVER MOWER



Introducing the **MHM480 Hover Mower**, featuring a compact design and powerful 79.2cc 2-cycle engine, giving you the ability to cut even the most difficult terrains at any angle. Includes 3 stainless steel reversible blades.

Ideal for the following applications:

- Steep slopes
- Hard-to-trim uneven areas, such as bunkers, embankments, sand traps, and landscaping privacy mounds
- Marshes
- Water lines and wet, grassy areas

## OPTIONAL KITS



STRAIGHT BAR BLADE KIT



HANDLE EXTENSION KIT



TRANSPORT WHEEL KIT



HEIGHT KIT

**NEW**

## MHM480

79.2 cc / CER800

39 lbs.

71 oz.



# 845995



# POLE PRUNERS



Our **Pole Pruner** and **Telescopic Pole Pruner** are commercial grade to tackle any job. They offer a powerful 2-cycle engine, 10" Oregon bar, and automatic chain oiler system.

- Commercial duty pruners
- Adjustable throttle control
- Reduced kickback bar & chain



## PS300



30.1 cc / CER300  
 15.0 lb  
 20.3 oz  
 10 in Oregon  
 Max output: 9700 rpm  
 Chain oil cap: 6.1 oz  
 Chain: 91PX  
 Pitch: 3/8 in  
 Overall length: 81 inches

# 365011  
 (Bar & chain included)

## TPP270



25.4 cc / CER260  
 15.7 lb  
 20.3 oz  
 10 in Oregon  
 Max output: 9700 rpm  
 Chain oil cap: 6.1 oz  
 Chain: 91PX / Pitch: 3/8 in

# 364866  
 (Bar & chain included)



# HEDGE TRIMMERS



**PRECISION  
SHARPENED  
BLADES**  
on ALL 3 SIDES

**FORWARD  
FACING EXHAUST**  
No brown spots on hedges  
due to downward exhaust.

## **Solid. Dependable. Simply The Best.**

The finest hedge trimmer available today. Great for sculpting, shearing or reaching high branches, these extraordinary hedge trimmers are engineered to balance power, durability and comfort under heavy, daily use. Every Maruyama hedge trimmer features induction hardened steel blades and dual reciprocating movement for maximum shearing force. Better yet, every Maruyama hedge trimmer features precision ground and polished cutting edges for the cleanest cuts and minimum leaf “browning”.

All Maruyama hedge trimmers use the state-of-the-art CER engines, which are light-weight and powerful. The CER engine family is unrivaled in power to weight performance as well as being a low emission, compliant engine which uses far less fuel than previous generation engines.





### H23F

- 22.5cc / CER230
- 12.5 lb
- 13.5 oz
- Length = 30 in
- 
- #362408**



### H23FL

- 22.5cc / CER230
- 13.8 lb
- 13.5 oz
- Length = 40 in
- 
- #362409**



### H23DF

- 22.5cc / CER230
- 13.0 lb
- 13.5 oz
- Length = 24 in
- 
- #362404**



### H23DFL

- 22.5cc / CER230
- 13.9 lb
- 13.5 oz
- Length = 30 in
- 
- #362405**

# MORE POWER FOR THE PROS!



5-POSITION ROTATING HANDLE



### H23DFR

- 22.5cc / CER230
- 11.7 lb
- 13.5 oz
- Length = 24 in
- 
- #362406**



### H23DFLR

- 22.5cc / CER230
- 12.6 lb
- 13.5 oz
- Length = 30 in
- 
- #362407**



**FORWARD EXHAUST SYSTEM**  
to eliminate hot downward exhaust onto shrubs



**PRECISION SHARPENED BLADES**  
on ALL 3 SIDES

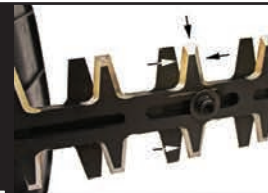

**SUPERIOR AIR FILTER**  
on intake to prevent dirt, sand, etc. from entering carburetor



**5-POSITION HANDLE**  
5-Position handle (R) on H23DFR & H23DFLR for easy hedge trimming

- Displacement (cc)
- Dry Weight (lb)
- Fuel Tank Capacity (oz)
- Adjust. Throttle w/Anti-Vibration Grip
- Tank Retention Ring
- Ergonomic Pull
- Easy Start
- 1-Side
- 2-Sides
- 5-Position Handle



D = Double, F = Forward Exhaust, L = Long Blade, R = Rotating Handle

# EXTENDED-REACH HEDGE TRIMMERS



- Iron 5-yr commercial warranty
- Lightweight
- Lifetime warranty on driveshafts
- Extreme-duty gearboxes - fixed and articulating models
- Industrial hardened steel blades on all Maruyama hedge trimmers

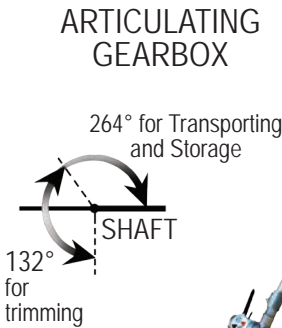

## EH230DSL

- 22.5 cc / CER230
- 14.3 lb
- 16.9 oz
- Length: 24 in
- Shaft: 54 in
- Reach: 90 in
- # 364864

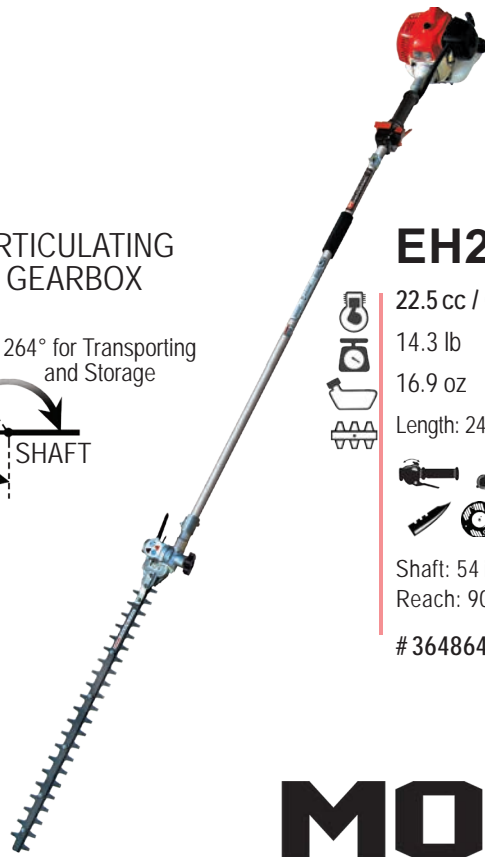

**MORE  
POWER  
FOR THE PROS!**

## EH230D

- 22.5 cc / CER230
- 13.3 lb
- 16.9 oz
- Length: 20 in
- Shaft: 20 in
- Reach: 55 in
- 2-edge sharp blades
- Fixed gearbox
- # 364863

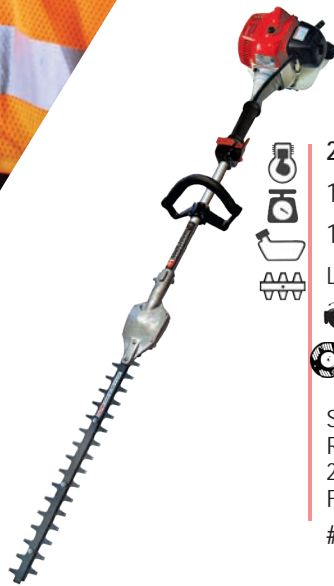

## EH270D-S

- 25.4 cc / CER260
- 13.4 lb
- 20.3 oz
- Length: 20 in
- Shaft: 20 in
- Reach: 55 in
- 3-edge sharp blades
- Fixed gearbox
- # 364865

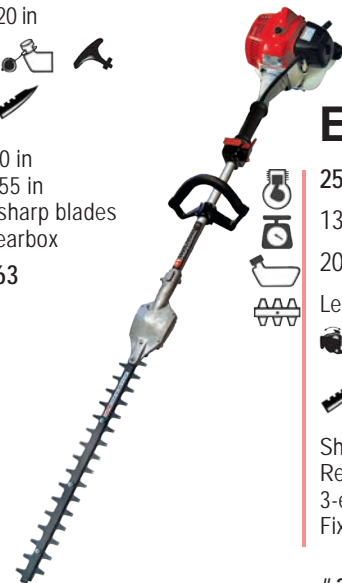





## ENTRY LEVEL PROFESSIONAL EQUIPMENT

- Warranty - 5-yr consumer / 1-yr commercial
- High-powered Maruyama CER engines



### BT230L TRIMMER

- 22.5 cc / CER230
- 10.1 lb
- 16.9 oz
- 
- # 364845



### BH24G HEDGE TRIMMER

- 22.5 cc / CER230
- 11.6 lb
- 13.5 oz
- Length: 24" Rear fixed handle
- Blades sharpened on 2 edges
- 
- # 362410



### BM240 MULTI-CUTTER

- 22.5 cc / CER230
- 9.9 lb
- 20.3 oz
- 
- Quick-Connect™
- QC tool attachments
- \* SEE PAGE 11 FOR QC TOOL ATTACHMENTS
- # 364847

Multi-Cutters come with powerhead and shaft only



# EDGERS - STRAIGHT & CURVED



## ADJUSTABLE BLADE HEIGHT

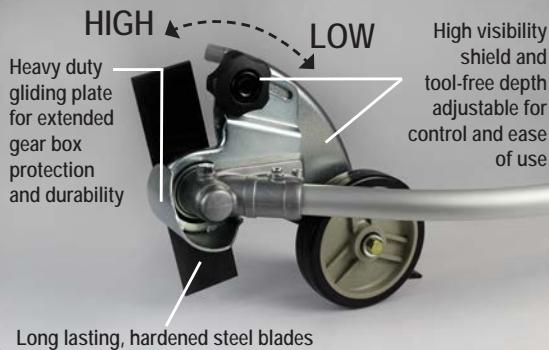

- Commercial duty edger
- Easy start system
- Adjustable throttle control
- Dual anti-vibration system
- Heavy duty gearbox protection
- Adjustable blade height



**E270**

- 24.5cc / CER260
- 13.2 lb
- 20.2 oz
- #364861**
- 



**E300S**

- 30.1cc / CER300
- 14 lb
- 20.2 oz
- #364862**
- \* STRAIGHT SHAFT
- 



# LANDSCAPE BLADE

While cutting with the landscape blade unit, there is virtually no flying gravel or debris damaging your trees, plants or even cars in parking lots. With the landscape blade unit, you target exactly what needs to be cut. The LB300 provides impressive cutting and edging around lawns, gardens, bunkers and sand traps.

**MORE  
POWER  
FOR THE PROS!**



## LB300

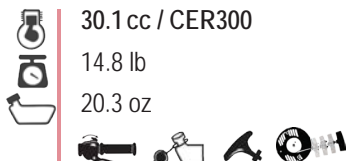

30.1 cc / CER300

14.8 lb

20.3 oz

Overall length: 75 in  
LANDSCAPE BLADE-V6

# 365013



Maruyama offers the only landscape blade that cuts in and around water areas, bunkers, sand traps and rock without launching objects everywhere.



The Landscape Blade-V6 features two independent round, tooth blades that move in opposite directions for smooth, clean cutting.



## MORE POWER FOR THE PROS!



**OPTIONAL:**  
**TORNADO TIP BL9000**  
Increase air volume  
#276352



**OPTIONAL:**  
**TORNADO TIP BL70**  
Increase air volume  
#131870



**AIR CONDITIONED PADDING  
AND WIDE SHOULDER STRAPS**



**ADJUSTABLE  
THROTTLE PISTOL**

## HAND-HELD BLOWER



**BL32**



**30.1cc / CER300**

9.4 lb

18.6 oz

**#395833**



Sound rating .....70 dB(A)

AIR volume .....~455 cfm

AIR velocity .....180 mph



**ADJUSTABLE  
THROTTLE  
CONTROL**



**OPTIONAL:**  
**SHREDDER/  
VACUUM  
ATTACHMENT KIT**  
w/ heavy-duty steel  
shredder blade (included)  
**#395747**



# BACK PACK BLOWERS



## BL70-SP

60.9CC / CER600  
 20.9 lb  
 71 oz  
**#395885**



Sound rating .....75 dB(A)  
 AIR volume\* .....~885 cfm  
 AIR velocity\* ..... 185 mph  
 Throttle Type.....Pistol



## BL70-HA

60.9CC / CER600  
 20.9 lb  
 71 oz  
**#395884**



Sound rating .....75 dB(A)  
 AIR volume\* .....~885 cfm  
 AIR velocity\* ..... 185 mph  
 Throttle Type.....Hip Assist



## BL9000-GT

79.2cc / CER800  
 24 lb  
 71 oz  
**#395880**



Sound rating .....78 dB(A)  
 AIR volume\* .....~1068 cfm  
 AIR velocity\* ..... 185 mph  
 Throttle Type.....Pistol



## BL9000-GT-HA

79.2cc / CER800  
 24 lb  
 71 oz  
**#395881**



Sound rating .....78 dB(A)  
 AIR volume\* .....~1068 cfm  
 AIR velocity\* ..... 185 mph  
 Throttle Type.....Hip Assist



## BL9000

79.2 cc / CER800  
 24.0 lb  
 71.0 oz  
**#395857**



Sound rating .....78 dB(A)  
 AIR volume .....~1068 cfm  
 AIR velocity\* ..... 185 mph  
 Throttle Type.....Pistol



## BL9000-HA

79.2cc / CER800  
 24.0 lb  
 71.0 oz  
**#395863**



Sound rating .....78 dB(A)  
 AIR volume .....~1068 cfm  
 AIR velocity\* ..... 185 mph  
 Throttle Type.....Hip Assist



# CHAINSAWS



## PRE-VENT SYSTEM

Debris and sawdust are dispersed leaving only clean air running through the carburetor

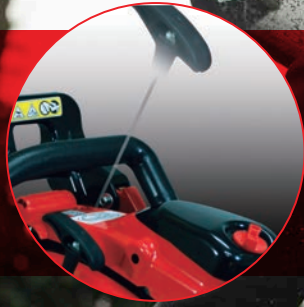

## EASY START

Easy Start System incorporates the best features of an electric starter for fast and easy starters



## ANTI-VIBRATION

Double protection for the operator



## Compact. Balance. Extreme duty.

Maruyama's chainsaws are ideal for professional landscapers and tree-care specialists. Best used for cutting firewood, clearing land, and forestry. Great for cleaning up after natural disasters.



# MORE POWER FOR THE PROS!

- Commercial duty chainsaws
- Powerful yet lightweight!
- Automatic oiling system
- Reduced kickback bar & chain
- eJUST™ tensioning system



## PROFESSIONAL CHAINSAWS

### MCV31T-14



30.1 cc / CER300

7.1 lb

8.1 oz

14 in Oregon



Max output: 12000 rpm

Chain oil cap: 6.1 oz

Chain: 91PX / Pitch: 3/8 in

# 362813 (Bar & chain included)



### MCV31R-14



30.1 cc / CER300

7.3 lb

8.1 oz

14 in Oregon



Max output: 12000 rpm

Chain oil cap: 6.1 oz

Chain: 91PX / Pitch: 3/8 in

# 362812 (Bar & chain included)

## PROFESSIONAL CHAINSAW ACCESSORIES

#### PART NO. DESCRIPTION

**840481** Bar 10", 3/8" for PS30 and TPP27

**842460** Bar 12", 3/8" for MCV331T-12

**842461** Bar 14", 3/8" for MCV331R-14

**286828** Bar 14", 3/8" for MCV31R and MCV31T

**842467** Bar 18", 3/8" for MCV381

**840874** Bar 20", 3/8" for MCV51

**844049** Bar 20", .325" for MCV51

#### PART NO. DESCRIPTION

**840482** Chain 10", 3/8" for PS30 and TPP27

**842457** Chain 12", 3/8" for MCV331T-12

**842458** Chain 14", 3/8" for MCV331R-14

**842463** Chain 18", 3/8" for MCV381

**841025** Chain 18", 3/8" for MCV51R

**840715** Chain 20", 3/8" for MCV51R

**844050** Chain 20", .325" for MCV51

#### PART NO. DESCRIPTION

**841029** RIM Sprocket 0.325, 7T

**840483** RIM Sprocket 3/8", 7T



# PISTON PUMPS

MARUYAMA UNIFLOW™ TECHNOLOGY - Maruyama piston pumps utilize our patented, simple UNIFLOW™ design which ensures fluid moves in only one direction throughout the pump without changing its direction. The piston pumps require less horsepower to operate at peak performance. This technology is unsurpassed for efficiency and reduced fuel consumption.

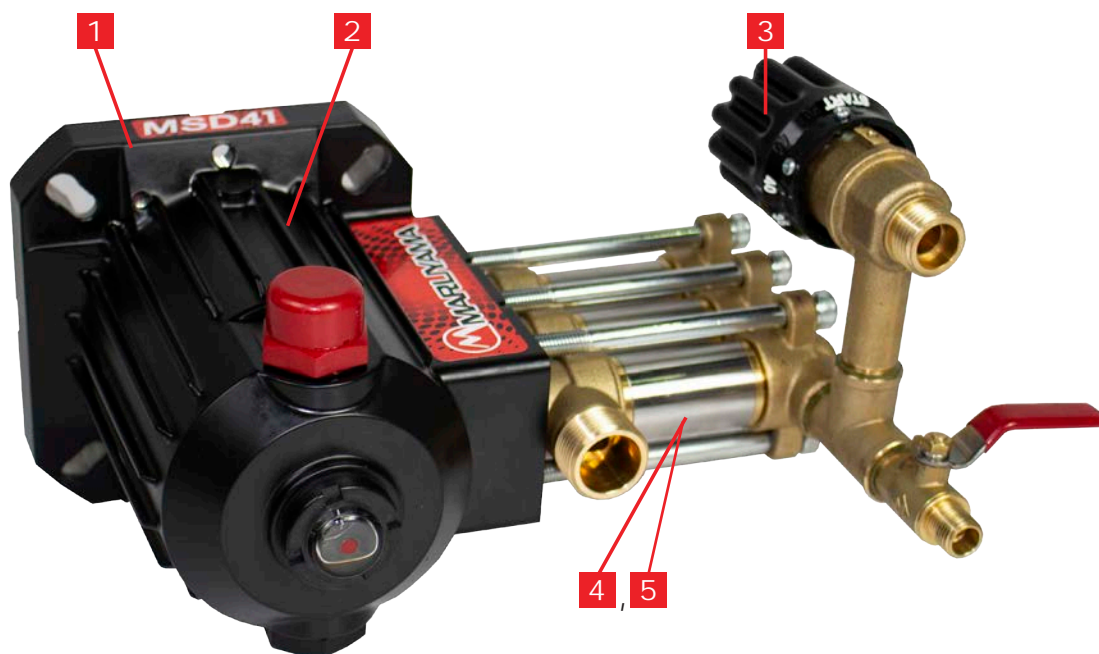

**MORE  
POWER  
FOR THE PROS!**

## 1. DIRECT COUPLING

Easy to mount to engine, reduced space and less components needed to complete the spray unit

## 2. RESISTANT CRANKCASE

Extremely durable materials for long term performance and corrosion resistance

## 3. PRESSURE REGULATOR

One knob to control working pressure and flow rates

## 4. HIGH EFFICIENCY CHROME CYLINDER

Chrome plated interior for increased resistance to abrasion, chemicals, and heat

## 5. SELF LUBRICATING AND SELF COOLING

The fluid moving through the pump provides lubrication and cooling for the pump





## DIRECT DRIVE PISTON PUMPS



	<b>MSD41 3/4"</b>	<b>MSD41 5/8"</b>	<b>MSD51 3/4"</b>
Cylinders	3	3	3
Cylinder coating	CHROME	CHROME	CHROME
Direct drive type	GASOLINE	ELECTRIC	GASOLINE
Dry weight	11.7 lbs	11.7 lbs	17.2 lbs
Pressure (psi max.)	570	570	570
Suction volume (gpm @ 3600RPM)	8 gpm	8 gpm	10.5 gpm
Maximum RPM	3600	3600	3600
Required power (approx)	3.6 HP	3.6 HP	5.0 HP
Part number	<b>366537</b>	<b>366538</b>	<b>366559</b>

## BELT-DRIVEN PUMPS



	<b>MS333</b>	<b>MS417</b>	<b>MS657</b>	<b>MS757</b>
Cylinders	3	3	3	3
Cylinder coating	CERAMIC	CERAMIC	CERAMIC	CERAMIC
Drive type	BELT	BELT	BELT	BELT
Dry weight	15.9 lbs	24.3 lbs	41.9 lbs	44.0 lbs
Pressure (psi max.)	510	725	725	725
Suction volume (gpm)	7.9	8.5	14.5	17.5
Maximum RPM	1050	1100	1000	950
Required power	2.8 HP	4.3 HP	7.4 HP	9.0 HP
Part number	<b>366572</b>	<b>354230</b>	<b>354233</b>	<b>354234</b>



# PISTON PUMP ENGINE COMBOS

**Versatile as a power sprayer, simple as a re-power kit.**

Assembled from components matched for compatibility and superior quality, Maruyama spray piston pump engine combos are unrivaled for performance and extraordinary durability.



Pump/Engine Combos	<b>MSD41TEC-H</b>	<b>MS333ECH</b>	<b>MS417ECH</b>
4-cycle - Honda-GX 160cc Engine (Approx. Hp)	5.5	5.5	5.5
Drive type	DIRECT	BELT	BELT
Pump type	Triplex piston	Triplex piston	Triplex piston
Cylinder Coating	CHROME	CHROME	CERAMIC
Spray Volume	8.0 gpm	6.0 gpm	7.9 gpm
Max Pressure	570 psi	500 psi	700 psi
Dry weight	71.6 lbs	79.3 lbs	88.1 lbs
Agitation	liquid bypass	liquid bypass	liquid bypass
Part Number	<b>366545</b>	<b>358669</b>	<b>358668</b>



Each pump combo includes suction hose, strainer assembly and bypass hose

**MORE  
POWER  
FOR THE PROS!**



# SKID SPRAYERS



*Product design and specification may be changed without prior announcement.*

- Choice of THREE chemical tank sizes: 50, 100, & 200 gallon
- Maruyama's Legendary UNIFLOW™ Piston Pump: MSD41 or MSD51 (direct drive) paired with Honda GX160 and GX200 engines
- Corrosion resistant aluminum frame
- Durable polyethylene tanks
- Stacked "TOPS" only available on 50 and 100 gallon configuration
- Optional electric reel
- 100% commercial-grade
- Complete line of optional guns, wands, nozzles and extensions available

## MSD41 Direct Drive Pump

Maruyama's UNIFLOW PISTON PUMPS are legendary throughout the world.

(MSD41 pump specs on pg. 25)



## MSD41T 3/4" PUMP 50 GALLON ALUMINUM FRAME



## MSD41T 3/4" PUMP 200 GALLON ALUMINUM FRAME



Model	<b>MSD41-50T</b>	<b>MSD41-50TE</b>	<b>MSD41-200</b>	<b>MSD41-200E</b>
Description	50 Gallon TOP	50 Gallon TOP	200 Gallon Standard	200 Gallon Standard
Frame	Aluminum	Aluminum	Aluminum	Aluminum
Dry Weight (lbs.)	208	223	310	325
Hose Reel	Manual	Electric	Manual	Electric
Length (inches)	42	42	60	60
Width (inches)	27	27	50	50
Height (inches)	37	37	43.5	43.5
Part Number	<b>849302</b>	<b>849301</b>	<b>849308</b>	<b>849309</b>

## MSD41T 3/4" PUMP 100 GALLON ALUMINUM FRAME



Model	<b>MSD41-100T</b>	<b>MSD41-100TE</b>	<b>MSD41-100</b>	<b>MSD41-100E</b>
Description	100 Gallon TOP	100 Gallon TOP	100 Gallon Standard	100 Gallon Standard
Frame	Aluminum	Aluminum	Aluminum	Aluminum
Dry Weight (lbs.)	245	260	219	234
Hose Reel	Manual	Electric	Manual	Electric
Length (inches)	42	42	48	48
Width (inches)	27	27	48	48
Height (inches)	49.5	49.5	43.5	43.5
Part Number	<b>849304</b>	<b>849305</b>	<b>849306</b>	<b>849307</b>



### MSD51T 3/4" PUMP

#### 50 GALLON ALUMINUM FRAME



Model	<b>MSD51-50T</b>	<b>MSD51-50TE</b>	<b>MSD51-200</b>	<b>MSD51-200E</b>
Description	50 Gallon TOP	50 Gallon TOP	200 Gallon Standard	200 Gallon Standard
Frame	Aluminum	Aluminum	Aluminum	Aluminum
Dry Weight (lbs.)	208	223	310	325
Hose Reel	Manual	Electric	Manual	Electric
Length (inches)	42	42	60	60
Width (inches)	27	27	50	50
Height (inches)	37	37	43.5	43.5
Part Number	<b>849313</b>	<b>849312</b>	<b>849318</b>	<b>849319</b>

### MSD51T 3/4" PUMP

#### 100 GALLON ALUMINUM FRAME



Model	<b>MSD51-100T</b>	<b>MSD51-100TE</b>	<b>MSD51-100</b>	<b>MSD51-100E</b>
Description	100 Gallon TOP	100 Gallon TOP	100 Gallon Standard	100 Gallon Standard
Frame	Aluminum	Aluminum	Aluminum	Aluminum
Dry Weight (lbs.)	245	260	219	234
Hose Reel	Manual	Electric	Manual	Electric
Length (inches)	42	42	48	48
Width (inches)	27	27	48	48
Height (inches)	49.5	49.5	43.5	43.5
Part Number	<b>849314</b>	<b>849315</b>	<b>849316</b>	<b>849317</b>



# PORTABLE SPRAYERS



## Excellent Control, Performance and Results.

Maruyama portable power sprayers offer the best performance and durability in its class. Maruyama's unique UNIFLOW positive displacement piston pump offers a consistent pressure providing supreme chemical coverage and penetration. The continuous improvement allows us to reach working pressures of up to 356 psi. This allows us to effectively use a second lance and an endless number of specialized spray accessories. Ideal for the application of agrochemicals in agriculture, gardening, farms, greenhouses, open field crops, shrubs, fruit trees, vegetables and pest control applications.

**MORE  
POWER  
FOR  
THE PROS!**



# BACKPACK SPRAYER



## MS75



30.1 cc / CER300  
21.0 lb  
20.3 oz



Chem. tank capacity = 6.6 gal  
Suction volume = 1.9 gpm  
4-dial pressure settings = 90, 180, 270, & 356

Liquid bypass agitation

# 353028

### Optional Cart

- Aluminum, non-caustic finish
- Lightweight & sturdy
- Rubber tires

# 645941

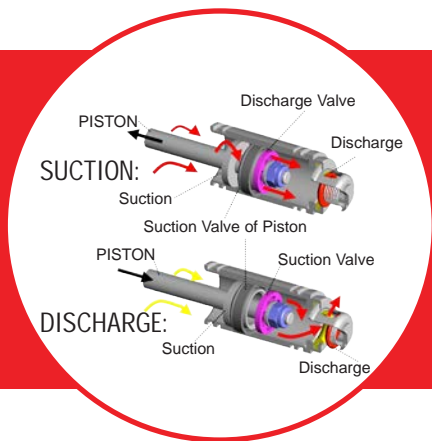

- Maruyama Patented Uniflow™ Technology
- Self-priming, self-lubricating and self-cooling Dual piston pump for increased pressure

# BARREL TOP SPRAYER

VERSATILE & COMPACT

## MS75E



30.1 cc / CER300  
16.3 lb  
20.3 oz



Suction volume = 1.9 gpm  
4-dial pressure settings = 90, 180, 270, & 356  
Liquid bypass agitation

# 353027



Maruyama's Barrel Top Sprayer Comes COMPLETE!  
Includes: pump, suction and bypass hoses, 20m of hose and a U2L spray gun (#116126)

# SPOT SPRAYER

## MS75E-25 SS



30.1 cc / CER300  
36.0 lb  
20.3 oz



Compact dimensions:  
34" w x 18" d x 26" h

Chem. tank capacity = 25 gal  
Suction volume = 1.9 gpm  
4-dial pressure settings = 90, 180, 270, & 356

Liquid bypass agitation

# 849094



Displacement (cc)



Dry Weight (lb)



Fuel Tank Capacity (oz)



Adjust. Throttle w/Anti-Vibration Grip



Tank Retention Ring



Ergonomic Pull



Easy Start

# BACKPACK MISTERS & DUSTER



## BRAND NEW MM91 -V MIST BLOWER

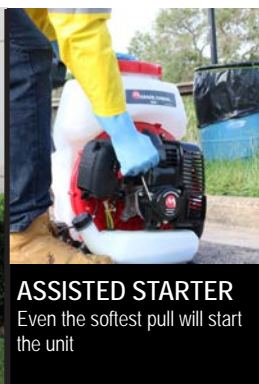

**ASSISTED STARTER**  
Even the softest pull will start the unit



**LIQUID WEIGHT BALANCE**  
Even distribution of chemicals during application

20%

80%



**ADJUSTABLE HANDLE**  
Improved tube control



**NEW BOOSTER NOZZLE**  
Improved coverage



**HEAVY DUTY FAN**  
One piece design for durability





MISTER  
**MM300**



30.1 cc / CER300

15.65 lb

20.3 oz

Chem. tank capacity = 3.43 gal

# Flow settings = variable

Sub-25 MICRON droplets  
for long hang times

# 352799



**ULV-F**  
for **MM300**

# 841068

*Fogger Attachment  
shown on MM300 MISTER*



MM300  
Mister Tip



FOGGER Tip for droplets  
sub 25 microns

DROPLET TEST:  
SMD= 55-64 microns

**MORE  
POWER  
FOR THE PROS!**

MISTER  
**MM91-V**



79.2 cc / CER800

25.6 lb

67.8 oz

Chem. tank capacity = 3.43 gal

# Flow settings = 4

# 352873



DUSTER  
**MD300**



30.1 cc / CER300

19.4 lb

20.3 oz

# Flow settings = 27 (3x9)

# 352826



# BATTERY SPRAYER

- IRON 5-Yr COMMERCIAL WARRANTY
- RECHARGABLE Lithium-Ion battery (battery covered by Makita warranty)
- Lightweight and extremely durable



## MS40Li



Dry weight = 11.7 lb  
Tank capacity = 3.9 gal  
Volume = 0.39 gpm  
Charging time = 22 minutes  
Variable Pressure = 145 / 72 / 43 psi  
Working time = 45 / 120 / 300 min  
Lithium ION battery =  
Makita 18V-3.0Ah BL1830 (# 133560)

# 353080



PIVOTING TANK  
Better weight distribution  
of liquid during use



Shown with  
1-pt adjustable nozzle #127460  
(included)



Shown with  
black dual wide-nozzle #471938  
(included)



Adjustable nozzle #127460  
and telescopic nozzle pipe  
#465077  
(optional)



## MANUAL SPREADER AND DUSTER

### MG51

#### MANUAL DUSTER



Dry weight = 6.2 lb  
 Tank cap. = 1.2 gal  
 Volume (powder) = 0-14.2 oz/min  
 # 338129



### MG10

#### MANUAL SPREADER



Dry weight = 3.7 lb  
 Tank cap. = 3.0 gal  
 Volume (granules) = 77.8 oz/min  
 # 338119



## TRENCHING TOOL



Using the T300 trenching tool gives quick access to foundations, etc. for more targeted termite treatments

### T300



30.1CC / CER 300



Dry weight = 16 lb



Tank cap. = 20.3 oz

# 365012



- Solid steel driveshaft
- CARB & EPA compliant
- 5yr commercial warranty



## WATER PUMP

- Powerful 30.1cc 2-Cycle engine
- Iron-5yr commercial warranty
- Amazing 32 gallon per minute flow rate
- Cast iron impellers and silicon carbide pump seals
- Ceramic mechanical seals
- Easy start system – spring assist technology for easy starting

### MIP2534S

#### PORTABLE WATER PUMP



30.1CC / CER 300



11 lb



20.3 oz

# 332334



Optional irrigation and fire suppression kit available # 286705



Displacement (cc)



Dry Weight (lb)



Fuel Tank Capacity (oz)



Adjust. Throttle w/Anti-Vibration Grip



Tank Retention Ring



Ergonomic Pull



Easy Start

# SPRAYER ACCESSORIES

## SPRAY GUNS AND ATTACHMENTS

FOR PORTABLE AND BACKPACK SPRAYERS



#353028 MS75 + #116126 U2L Gun



#471938 Wide Nozzle Ass'y



#074206 Ring Type 5-Head Nozzle A



#417232 2-Nozzle Wand, Length 17cm

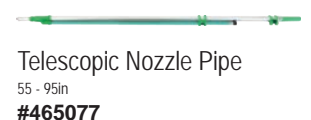

# SPRAY GUNS AND ATTACHMENTS

FOR SKID SPRAYERS

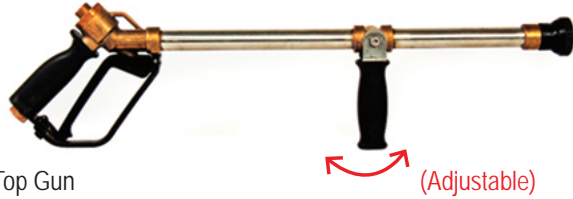

Top Gun  
#832505

(Adjustable)



#832505 Top Gun (different spray settings)



#417257 High End Nozzle (different spray settings)



Soil Injector  
#639258



#639258 Soil Injector



High End Nozzle  
#417257

(Adjustable)



Super Zoom P-700  
#417221

(Adjustable)



4-Nozzle Boom  
#637153

## NOZZLES FOR MD9 GUN

- #840925 #6 Nozzle, 2.5mm, 3.6 gpm (included)
- #842441 #2 Nozzle, 0.8 mm, 0.3-1.0 gpm (optional)
- #842442 #4 Nozzle, 1.5mm, 1.0-3.0 gpm (optional)
- #842443 #5 Nozzle, 2mm, 2.0-5.0 gpm (optional)
- #842444 #8 Nozzle, 3mm, 3.0-8.0 gpm (optional)



MD9 Gun  
#842404

(Adjustable)



# TRIMMER HEADS

## M-TWIST LOW PROFILE BUMP HEAD

### M-Twist EASY FEED Bump Head

PREMIUM trimmer bump head with metal bump plate for longer life

# EASY!



4.5 in. **M-Twist EZ-FEED**  
(LFT hand M/F) - 24-ct Display Pkg  
# 463743  
Accepts line up to & including 0.130" round.



5.5 in. **M-Twist EZ-FEED**  
(LFT hand M/F) - Bulk Packaging  
# 426930 (Best bump head for 41.5cc equipment)  
Accepts line up to & including 0.130" & 0.155" round.

### HEAD FOR CURVED SHAFT TRIMMER



4.5 in. Semi Auto Head  
for curved shaft trimmer  
# 840418



1. Line up the arrow on the head with the eyelet



2. Feed the trimmer line through the head



3. Pull line through\* - make both sides equal lengths



4. Twist head "clockwise" until -8" trimmer line shows

NOTE: If loading line from a spool, two extended arm lengths is good.



4.5" EZ-FEED  
POP-UP RETAIL DISPLAY

## FIXED-LINE TRIMMER HEADS - LOW PROFILE

### KATANA AKAI (RED)

The KATANA AKAI fixed-line head is made of a very durable alloy and is very lightweight.

Accepts all of Maruyama's trimmer line weights, EXCEPT 0.155 square.

**AKAI - 4 in. Fixed Line Head**  
Clamshell Packaging  
# 840337



### FIXED LINE HEAD - 4 in.

The aluminum fixed-line head is very durable and incredibly lightweight.

Accepts all of Maruyama's trimmer line weights, INCLUDING 0.155 square.

**Aluminum Fixed Line Head**

# 288424



### FIXED LINE HEAD ADAPTER

**Fixed Lined Head Adapter Standard Trimmer**  
# 212986



**Fixed Lined Head Adapter Turbo Trimmer**  
# 232927



## COMMERCIAL TRIMMER LINE

Maruyama's heavy-duty trimmer line has a resistant outer layer (round, square & twist) to reduce noise and friction, improving cutting efficiency



### XDR - ROUND RED

PART NO.	DESCRIPTION	UNITS/CS
845501	.095" / 288.6ft / 1.0lb donut	12
845502	.095" / 865.6ft / 3.0lb spool	4
845503	.095" / 1442.4ft / 5.0lb spool	4
845505	.105" / 239ft / 1.0lb donut	12
845506	.105" / 716.6ft / 3.0lb spool	4
845507	.105" / 1194.2ft / 5.0lb spool	4
845509	.130" / 154.1ft / 1.0lb donut	12
845510	.130" / 462.1ft / 3.0lb spool	4
845511	.130" / 770.1ft / 5.0lb spool	4
845512	.155" / 106.7ft / 1.0lb donut	12
845513	.155" / 319.7ft / 3.0lb spool	4
845514	.155" / 532.8ft / 5.0lb spool	4

### EDGE - SQUARE ORANGE

PART NO.	DESCRIPTION	UNITS/CS
845516	.095" / 288.6ft / 1.0lb donut	12
845517	.095" / 686.3ft / 3.0lb spool	4
845518	.095" / 1143.9ft / 5.0lb spool	4
845520	.105" / 187.7ft / 1.0lb donut	12
845521	.105" / 562.5ft / 3.0lb spool	4
845522	.105" / 937.5ft / 5.0lb spool	4
845524	.130" / 121.0ft / 1.0lb donut	12
845525	.130" / 362.7ft / 3.0lb spool	4
845526	.130" / 604.5ft / 5.0lb spool	4
845527	.155" / 82.4ft / 1.0lb donut	12
845528	.155" / 247.1ft / 3.0lb spool	4
845529	.155" / 411.8ft / 5.0lb spool	4

### SONIC - TWIST BLUE

PART NO.	DESCRIPTION	UNITS/CS
845531	.095" / 277.2ft / 0.8lb donut	12
845532	.095" / 1,390.3ft / 4.0lb spool	4
845533	.095" / 3,129.1ft / 9.0lb spool	1
845534	.095" / 6,255ft / 18.0lb donut	1
845536	.105" / 236.2ft / 0.8lb spool	12
845537	.105" / 1,184ft / 4.0lb spool	4
845538	.105" / 2,155ft / 9.0lb donut	1
845539	.105" / 4,312.2ft / 18.0lb spool	1
845541	.130" / 123ft / 0.8lb spool	12
845542	.130" / 618ft / 4.0lb donut	4
845543	.130" / 1,346ft / 9.0lb spool	1



## BLADES AND HANDLEBAR KITS



PART NO.	DESCRIPTION
<b>3-TOOTH BLADE</b>	
227910	9"/230 mm blade w/1" arbor
841380	10"/255 mm blade w/1" arbor
<b>4-TOOTH BLADE</b>	
210179	9"/230 mm blade w/1" arbor
054751	10"/255 mm blade w/1" arbor
<b>8-TOOTH BLADE</b>	
840895	10"/255 mm blade w/1" arbor



PART NO.	DESCRIPTION
<b>26-TOOTH SAW BLADE</b>	
840956	10"/255 mm blade w/1" arbor
<b>40-TOOTH SAW BLADE</b>	
841384	10"/255 mm blade w/1" arbor
<b>80-TOOTH SAW BLADE</b>	
422408	10"/255 mm blade w/1" arbor
<b>EDGER BLADE</b>	
840378	.098 edger blade

### HANDLEBAR ADAPTER KITS

Recommended for metal blade usage  
- For bullhorn/handlebar configuration.



PART NO.	DESCRIPTION
242583	Handlebar Kit for Standard Trimmers
- Not including B230C / B23C, B420 / B42L, BIG-M BT230C / BT23C, and BT230L / BT23L	
242585	Handlebar Kit for TURBO Trimmers
- Includes all Maruyama Turbos, including Turbo tool attachments	

### ADJUSTABLE THROTTLE KIT

Recommended for better control.

PART NO. 242591

DESCRIPTION

Adjustable Throttle Kit

Not compatible with B230C / B23C, B420L / B42L, and TPP270 / TPP27



## SAFETY AND PROMOTIONAL PRODUCTS



234477  
Heavy-duty, Full Back Support Brush Cutter Harness



228086  
Orange, Full Support Brush Cutter Harness



220533  
Quick-Release Brush Cutter Shoulder Strap



420282  
Forestry Helmet, Visor w/Hearing Protection



845493 - Smoke  
845492 - Clear  
Safety Glasses w/ LOGOS - 12/box



845670  
12-ply, Adjustable Wrap-Around Safety Chaps

## WEARABLES



CAMOUFLAGE  
- w/ branch-leaf pattern  
# 845818



"LEGALIZE" CAMOUFLAGE  
- w/ branch-leaf pattern  
# 845818A



RED MESH Back  
- w/ GREY bill  
# 845921



WHITE MESH Back  
- w/ GREY bill  
# 845921A



BLACK MESH Back  
- w/ GREY bill  
# 845922

### "LEGALIZE" MARUYAMA CAMO



Cool, Dry-Weave Shirts  
Digital camo design on dark green dry-weave shirt.  
Feels great and looks great!

100% POLYESTER

S	# 845744
M	# 845745
L	# 845746
XL	# 845747
2XL	# 845748
3XL	# 845749



### Maruyama Black Tokyo T-Shirts

Gildan 4.5 oz.  
65/35 polyester/cotton blend

S	# 845796
M	# 845827
L	# 845828
XL	# 845829
2XL	# 845830
3XL	# 845831



# MODEL SPECIFICATIONS

## TRIMMERS AND BRUSH CUTTERS

Model	Part Number	Displacement	Carb/EPA Engine	Dry Weight	Fuel Tank Capacity	Easy Start	Driveshaft Diameter	Driveshaft	Reduct G-Box Ratio	Adjust. Throttle	Pull Start	Fuel Cap Ret. Ring	Loop Handle	Bump Head	Page No.
B230C curved	364848	22.5cc	CER230	10.5 lb	16.9 oz	✓	curved	flex	direct drive		ergo	✓	✓	4.5 in	8
B230L	364849	22.5cc	CER230	11.3 lb	16.9 oz	✓	7mm	solid steel	1.46 : 1	✓	ergo	✓	✓	4.5 in	8
B270L	364850	25.4cc	CER260	11.7 lb	20.3 oz	✓	7mm	solid steel	1.46 : 1	✓	ergo	✓	✓	4.5 in	8
B270L TURBO	364851	25.4cc	CER260	12.1 lb	20.3 oz	✓	7mm	solid steel	1.92 : 1	✓	ergo	✓	✓	4.5 in	8
B270L TURBO (HI)	364852	25.4cc	CER260	12.1 lb	20.3 oz	✓	7mm	solid steel	1.92 : 1	✓	ergo	✓	✓	fixed	8
B300L	364853	30.1cc	CER300	11.5 lb	20.3 oz	✓	7mm	solid steel	1.46 : 1	✓	ergo	✓	✓	4.5 in	8
B300L TURBO	364854	30.1cc	CER300	12.2 lb	20.3 oz	✓	7mm	solid steel	1.92 : 1	✓	ergo	✓	✓	4.5 in	8
B300L TURBO (HI)	364855	30.1cc	CER300	12.2 lb	20.3 oz	✓	7mm	solid steel	1.92 : 1	✓	ergo	✓	✓	fixed	8
B420	364856	41.5cc	CER420	17.7 lb	33.8 oz	✓	8mm	solid steel	1.36 : 1		ergo	✓	bicycle	fixed	9
B420L	364857	41.5cc	CER420	16.4 lb	33.8 oz	✓	8mm	solid steel	1.36 : 1		ergo	✓	✓	5.5 in	8
BT230L	364845	22.5cc	CER230	10.1 lb	16.9 oz		7mm	solid steel	1.46 : 1	✓	ergo	✓	✓	4.5 in	17
BT230L (HI)	364846	22.5cc	CER230	10.1 lb	16.9 oz		7mm	solid steel	1.46 : 1	✓	ergo	✓	✓	fixed	17

## MULTI CUTTERS

Model	Part Number	Displacement	Carb/EPA Engine	Dry Weight	Fuel Tank Capacity	Easy Start	Driveshaft Diameter	Driveshaft	Reduct G-Box Ratio	Adjust. Throttle	Pull Start	Fuel Cap Ret. Ring	Loop Handle	Bump Head	Page No.
M270QC split shaft	364858	25.4cc	CER260	10.4 lb	20.3 oz	✓	7mm	solid steel	-	✓	ergo	✓	✓		10
M300QC split shaft	364859	30.1cc	CER300	10.1 lb	20.3 oz	✓	7mm	solid steel	-	✓	ergo	✓	✓		10
M420BK-QC	364860	41.5cc	CER420	23.4 lb	33.8 oz	✓	7mm	flexible steel	-		ergo	✓	✓		10
BM240 split shaft	364847	22.5cc	CER230	9.9 lb	20.3 oz	✓	7mm	solid steel		✓	ergo	✓	✓		17

## EDGERS

Model	Part Number	Displacement	Carb/EPA Engine	Dry Weight	Fuel Tank Capacity	Easy Start	Driveshaft Diameter	Driveshaft	Reduct G-Box Ratio	Adjust. Throttle	Pull Start	Fuel Cap Ret. Ring	Loop Handle	Bump Head	Page No.
E270 curved	364861	25.4cc	CER260	13.2 lb	20.2 oz	✓	curved	flex	1.33 : 1	✓	ergo	✓	✓	9" blade	18
E300S straight	364862	30.1cc	CER300	14.0 lb	20.2 oz	✓	7mm	solid steel	1.47 : 1	✓	ergo	✓	✓	9" blade	18

## LANDSCAPE BLADE / TILLER

Model	Part Number	Displacement	Carb/EPA Engine	Dry Weight	Fuel Tank Capacity	Easy Start	Driveshaft Diameter	Driveshaft	Reduct G-Box Ratio	Adjust. Throttle	Pull Start	Fuel Cap Ret. Ring	Loop Handle	Bump Head	Page No.
LB300	365013	30.1cc	CER300	14.8 lb	20.3 oz	✓	7mm	solid steel	-	✓	ergo	✓	✓		19
T300	365012	30.1cc	CER300	16.1 lb	20.3 oz	✓	7mm	solid steel	-	✓	ergo	✓	✓		35

## EXTENDED-REACH HEDGE TRIMMERS

Model	Part Number	Displacement	Carb/EPA Engine	Dry Weight	Fuel Tank Capacity	Easy Start	Driveshaft Diameter	Driveshaft	Reduct G-Box Ratio	Adjust. Throttle	Pull Start	Fuel Cap Ret. Ring	Loop Handle	Bump Head	Page No.
EH230D	364863	22.5cc	CER230	13.3 lb	16.9 oz	✓	7mm	solid steel	4.92 : 1	✓	ergo	✓	✓	20" blade	16
EH230DSL	364864	22.5cc	CER230	14.3 lb	16.9 oz	✓	7mm	solid steel	4.92 : 1	✓	ergo	✓		24" blade	16
EH270D-S	364865	25.4cc	CER260	13.4 lb	20.3 oz	✓	7mm	solid steel	4.92 : 1	✓	ergo	✓	✓	20" blade	16

## HEDGE TRIMMERS

Model	Part Number	Displacement	Carb/EPA Engine	Dry Weight	Fuel Tank Capacity	Forward Exhaust	Extreme Gearbox	Handle Type	Blade Length	Hardened Steel Blades	Sharp Edges	Page No.
H23F single	362408	22.5cc	CER230	12.5 lb	13.5 oz	✓	✓	offset 90°	30"	✓	3 edges	15
H23FL single	362409	22.5cc	CER230	13.8 lb	13.5 oz	✓	✓	offset 90°	40"	✓	3 edges	15
H23DF double	362404	22.5cc	CER230	13.0 lb	13.5 oz	✓	✓	fixed	24"	✓	3 edges	15
H23DFL double	362405	22.5cc	CER230	13.9 lb	13.5 oz	✓	✓	fixed	30"	✓	3 edges	15
H23DFR double	362406	22.5cc	CER230	11.7 lb	13.5 oz	✓	✓	5-rotation	24"	✓	3 edges	15
H23DFLR double	362407	22.5cc	CER230	12.6 lb	13.5 oz	✓	✓	5-rotation	30"	✓	3 edges	15
BH24G	362410	22.5cc	CER230	11.6 lb	13.5 oz	✓	✓	fixed	24"	✓	2 edges	17





## HOVER MOWER

Model	Part Number	Displacement	Carb/EPA Engine	Dry Weight	Fuel Tank Capacity	Start Assist	Fuel Cap Ret. Ring	Cutting Width	Cutter System	Cutting Height	Page
MHM480	845995	79.2cc	CER800	39 lb	71 oz	√	√	19 inch	3 blades	2.25"-2.75"	12

## PORTABLE WATER PUMP

Model	Part Number	Displacement	Carb/EPA Engine	Dry Weight	Fuel Tank Capacity	Easy Start	Suction Volume	Pump Head	Intake Port	Discharge Port	Page
MIP2534S	332334	30.2cc	CER300	11.0 lb	20.3 oz	√	30 gpm	118ft	1"	1"	35

## BLOWERS

Model	Part Number	Displacement	Carb/EPA Engine	Dry Weight	Fuel Tank Capacity	Throttle Type	Air Volume	Air Velocity	2-Stage Air Filtration	Sound Rating	Grill Cover & Tube	Page No.
BL9000	395857	79.2cc	CER800	24 lb	71 oz	pistol	~1068 cfm*	~185 mph*	√	78 dB(A)	√	21
BL9000-HA	395863	79.2cc	CER800	24 lb	71 oz	hip	~1068 cfm*	~185 mph*	√	78 dB(A)	√	21
BL9000-GT-SP	395880	79.2cc	CER800	24 lb	71 oz	pistol	~1068 cfm*	~185 mph*	√	78 dB(A)	√	21
BL9000-GT-HA	395881	79.2cc	CER800	24 lb	71 oz	hip	~1068 cfm*	~185 mph*	√	78 dB(A)	√	21
BL70-SP	395885	60.9cc	CER600	20.9 lb	71 oz	pistol	~885 cfm*	~185 mph*	√	75 dB(A)		21
BL70-HA	395884	60.9cc	CER600	20.9 lb	71 oz	hip	~885 cfm*	~185 mph*	√	75 dB(A)		21
BL32 hand held	395833	30.1cc	CER300	9.4 lb	18.6 oz	trigger	~455 cfm	~180 mph		70 dB(A)		20

\* Data recorded with the Tornado Tip attached. - Optional Tornado Tip available for the BL9000-GT models - #276352 and for the BL70 models - #131870

## CHAINSAWS

Model Name	Part Number	Displacement	Carb/EPA Engine	Dry Weight	Fuel Tank Cap.	Handle Type	Maximum Output	Chain Oil Capacity	Bar Length	Chain Type	Pitch	Page No.
MCV31T-14	362813	30.1cc	CER300	7.1 lb	8.1 oz	top	9500 rpm	6.1oz	14 in	91PX	3/8 in	23
MCV31R-14	362812	30.1cc	CER300	7.3 lb	8.1 oz	rear	9500 rpm	6.1oz	14 in	91PX	3/8 in	23

## POLE PRUNERS

Model	Part Number	Displacement	Carb/EPA Engine	Dry Weight	Fuel Tank Capacity	Start Assist	Driveshaft Diameter	Driveshaft	Reduct G-Box Ratio	Adjust. Throttle	Pull Start	Fuel Cap Ret. Ring	Loop Handle	Bump Head	Page No.
PS300 pole saw	365011	30.1cc	CER300	15.0 lb	20.3 oz	√	7mm	solid steel	-	√	ergo	√	√	10" bar	13
TPP270 telescopic	364866	25.4cc	CER260	15.7 lb	20.3 oz	√	7mm	solid steel	-	√	ergo	√	√	10" bar	13

## PORTABLE SPRAYERS

Model	Part Number	Displacement	Dry Weight	Chem. Tank Capacity	Fuel Tank Capacity	Carb/EPA Engine	Easy Start	Pump Type	Suction Volume	Pressure Settings	Pressure PSI	Liquid Aggitation	Page No.
MS75 backpack	353028	30.1cc	21.0 lb	6.6 gal	20.3 oz	CER300	√	dual piston	1.9 gpm	4	90, 180, 270 356 psi	√	31
MS75E barrel top	353027	30.1cc	16.3 lb	N/A	20.3 oz	CER300	√	dual piston	1.9 gpm	4	90, 180, 270, 356 psi	√	31
MS75E-25SS	849094	30.1cc	36.0 lb	25.0 gal	20.3 oz	CER300	√	dual piston	1.9 gpm	4	90, 180, 270 356 psi	√	31

## MISTERS AND DUSTER

Model	Part Number	Displacement	Dry Weight	Chem. Tank Capacity	Fuel Tank Capacity	Carb/EPA Engine	Easy Start	Pump Type	Tip Type	Flow Settings	Atomizer Volume	Dust Volume	Granular Volume	Page No.
MM300 mister	352799	30.1cc	15.65 lb	3.34 gal	20.3 oz	CER300	√	N/A	55-64 microns	variable	0-0.79 gpm	N/A	N/A	33
MM91-V mister	352873	79.2cc	25.6 lb	3.43 gal	67.8 oz	CER800		N/A		4	0-1.32 gpm	N/A	N/A	33
MD300 duster	352826	30.1cc	19.4 lb		20.3 oz	CER300		N/A		27 (3x9)		0-17.6 lb/min	0-35.3 lb/min	33

## BATTERY SPRAYER

Model	Part Number	Battery	Dry Weight	Chem. Tank Capacity	Volume	Pressure Settings	Pressure Variable	Working Time (Minutes)	Makita Battery	Items Included	Page No.
MS40Li Backpack	353080	Lithium-Ion	11.7 Lb	3.9 Gal	0.39 Gpm	3	45-145 Psi	45 / 120 / 300	18v-3 0ah Bli1830	Single Wand Nozzles #127460 & #117958	34



# PRODUCT SPECIFICATIONS CONT.

## CHEMICAL APPLICATION EQUIPMENT

### UNIFLOW PISTON PUMPS

Model	Part Number	Pump Drive Type	Number Cylinders	Direct Drive Type (PWR)	Cylinder Coating	Dry Weight	Suction Volume @ 3600 RPM	Maximum Pressure	Maximum RPM	Required Power	Page No.
MSD41 3/4"	366537	direct-drive	3	gasoline	chrome	11.7 lb	8 gpm	570 psi	3600 rpm	-3.6 hp	25
MSD41 5/8"	366538	direct-drive	3	electric	chrome	11.7 lb	8 gpm	570 psi	3600 rpm	-3.6 hp	25
MSD51 3/4"	366559	direct-drive	3	gasoline	chrome	17.2 lb	10.6 gpm	570 psi	3600 rpm	-5.0 hp	25
MS333	366572	belt-driven	3	gasoline	ceramic	15.9 lb	8 gpm	500 psi	1050 rpm	-2.6 hp	25
MS417	354230	belt-driven	3	gasoline	ceramic	24.3 lb	8.5 gpm	700 psi	1000 rpm	-3.5 hp	25
MS657	354233	belt-driven	3	gasoline	ceramic	48.0 lb	14.5 gpm	700 psi	1000 rpm	-6.0 hp	25
MS757	354234	belt-driven	3	gasoline	ceramic	52.5 lb	17.5 gpm	700 psi	950 rpm	-7.0 hp	25

### PUMP / ENGINE COMBOS

Model	Part Number	Pump Drive Type	Number Cylinders	Direct Drive Type (Pwr)	Cylinder Coating	Dry Weight	Suction Volume @ 3600 RPM	Maximum Pressure	Maximum RPM	Required Power	Honda 4-Cycle Engine	Items Included	Page No.
MSD41TEC-H	366545	direct-drive	3	gasoline	chrome	71.6 lbs	8 gpm	570 psi	3600 rpm	-5.5 hp =	GX160	suction hose, strainer assy & bypass hose	26
MS333ECH	358669	belt-driven	3	gasoline	chrome	79.3 lb	6 gpm	500 psi	1050 rpm	-5.5 hp =	GX160	suction hose, strainer assy & bypass hose	26
MS417ECH	358668	belt-driven	3	gasoline	ceramic	88.1 lb	7.9 gpm	700 psi	1000 rpm	-5.5 hp =	GX160	suction hose, strainer assy & bypass hose	26

### SKID SPRAYER - MSD41T 3/4" PUMP

Model	Part Number	Tank Volume	MSD41 Pump-Engine	Honda Engine 4-Cycle	Hose Reel Type	Volume gpm	Frame Finish	Frame Color	Dry Weight	Dimensions	Hose Diameter & Length	Page No.
MSD41-50T	849302	50-gal	3/4" gasoline	GX160	manual	8	aluminum	silver	208 lb	42" x 27" x 37"	3/8" / 328'	28
MSD41-50TE	849301	50-gal	3/4" gasoline	GX160	electric	8	aluminum	silver	223 lb	42" x 27" x 37"	3/8" / 328'	28
MSD41-100T	849304	100-gal	3/4" gasoline	GX160	manual	8	aluminum	silver	245 lb	42" x 27" x 49.5"	3/8" / 328'	28
MSD41-100TE	849305	100-gal	3/4" gasoline	GX160	electric	8	aluminum	silver	260 lb	42" x 27" x 49.5"	3/8" / 328'	28
MSD41-100 Standard	849306	100-gal	3/4" gasoline	GX160	manual	8	aluminum	silver	219 lb	48" x 48" x 43.5"	3/8" / 328'	28
MSD41-100E Standard	849307	100-gal	3/4" gasoline	GX160	electric	8	aluminum	silver	234 lb	48" x 48" x 43.5"	3/8" / 328'	28
MSD41-200 Standard	849308	200-gal	3/4" gasoline	GX160	manual	8	aluminum	silver	310 lb	60" x 50" x 43.5" h	3/8" / 328'	29
MSD41-200E Standard	849309	200-gal	3/4" gasoline	GX160	electric	8	aluminum	silver	325 lb	60" x 50" x 43.5" h	3/8" / 328'	29

### SKID SPRAYER - MSD51T 3/4" PUMP

Model	Part Number	Tank Volume	MSD41 Pump-Engine	Honda Engine 4-Cycle	Hose Reel Type	Volume gpm	Frame Finish	Frame Color	Dry Weight	Dimensions	Hose Diameter & Length	Page No.
MSD51-50T	849313	50-gal	3/4" gasoline	GX160	manual	8	aluminum	silver	208 lb	42" x 27" x 37"	3/8" / 328'	28
MSD51-50TE	849312	50-gal	3/4" gasoline	GX160	electric	8	aluminum	silver	223 lb	42" x 27" x 37"	3/8" / 328'	28
MSD51-100T	849314	100-gal	3/4" gasoline	GX160	manual	8	aluminum	silver	245 lb	42" x 27" x 49.5"	3/8" / 328'	28
MSD51-100TE	849315	100-gal	3/4" gasoline	GX160	electric	8	aluminum	silver	260 lb	42" x 27" x 49.5"	3/8" / 328'	28
MSD51-100 Standard	849316	100-gal	3/4" gasoline	GX160	manual	8	aluminum	silver	219 lb	48" x 48" x 43.5"	3/8" / 328'	28
MSD51-100E Standard	849317	100-gal	3/4" gasoline	GX160	electric	8	aluminum	silver	234 lb	48" x 48" x 43.5"	3/8" / 328'	28
MSD51-200 Standard	849318	200-gal	3/4" gasoline	GX160	manual	8	aluminum	silver	310 lb	60" x 50" x 43.5" h	3/8" / 328'	29
MSD51-200E Standard	849319	200-gal	3/4" gasoline	GX160	electric	8	aluminum	silver	325 lb	60" x 50" x 43.5" h	3/8" / 328'	29

# BLUE ULTRA-SHIELD

## PROTECTS CLEANS PERFORMS

- The most advanced technology in 2-cycle engine oil
- Superior synthetic blend oil that gives premium protection to internal moving parts reducing maintenance costs
- Formulated with fuel stabilizer
- Cleans engine and protects against carbon particle buildup
- Exceeds JASO-FD quality standards
- Promotes exceptional engine performance and long engine life
- Blue color makes it easy to identify gasoline mix in containers
- Mixes instantly with gasoline



PART #	DESCRIPTION	Bottles per Case	Cases per Pallet
849860	Blue Ultra-Shield - 2.6oz. Bottle (1-gal mix)	24	144
849861	Blue Ultra-Shield - 6.4oz. Bottle (2.5-gal mix)	24	128
849862	Blue Ultra-Shield - 12.8oz. Bottle (5-gal mix)	24	60



# MARUYAMA®



## COMMERCIAL WARRANTY

**5 Year Commercial / Residential warranty on qualified products with the purchase and use of Maruyama Blue Ultra-Shield oil**

**Lifetime Warranty for solid steel driveshafts and ignition coils on qualified units**

**5 Year Warranty available only through Authorized Maruyama Dealers**

**5 Year Warranty excludes Chainsaws, Big-M Pro-Scape products, and any unit used for rental purposes**

For more information regarding your products specific Maruyama warranty, please ask your Authorized Maruyama Dealer, visit [www.maruyama-us.com/warranty](http://www.maruyama-us.com/warranty), or consult the warranty card that comes with your product.



**MORE  
POWER  
FOR THE PROS!**

Contact Your Local Maruyama Dealer

[www.maruyama-us.com](http://www.maruyama-us.com)    /maruyama us

#845002\_RV.10.2023