

# F80P & F130P FLEX-SELECT® Series

## Adaptable Broadcast Spreader

### Assembly and Operating Instructions

**PLEASE CONTACT US:** IF YOU ARE MISSING ANY PARTS, HAVE ANY DIFFICULTY IN ASSEMBLY, OR HAVE ANY QUESTIONS REGARDING THE SAFE OPERATION OF THIS SPREADER. THIS MODEL INCLUDES LIFETIME TECHNICAL SUPPORT. **SUPPORT HOT LINE: 800-294-0671**

#### HELPFUL HINTS:

- ☑ If your spreader does not spread evenly, be sure the FRONT on the gear box points to the front of the spreader. The impeller must turn clockwise. Reversing the gearbox will cause the impeller to turn counter clockwise. Clean the impeller after each use as some fertilizer may become stuck on the impeller blades and will cause uneven spreading.
- ☑ Your spreader is designed to be pushed at three miles per hour, which is a brisk walking speed. Slower or faster speeds will change the spread patterns. Wet fertilizer will also change the spread pattern and flow rate.
- ☑ Clean and dry your spreader thoroughly after each use, wash between the shut-off plate and bottom of the hopper regularly. To prevent rust, coat all metal parts (inside and out) including the frame tubes with a light oil, silicon spray, or Fluid Film®.
- ☑ Gears are permanently lubricated at the factory. Do not open the gearbox or dirt may enter.
- ☑ When using **Rock Salt** to prevent damage to the gearbox remove salt from the hopper daily. **Rock Salt** will reconstitute back into a solid block if left in the hopper overnight and will damage your gearbox if pushed with the salt in place.



#### WARNING

Do not use air tools to assemble.  
To prevent seizing coat all bolts  
with a wax or grease prior to  
installation.

Remove all parts, hardware, and assemblies from carton and lay them out on the floor to help in assembly.

*Below are tools needed for assembly - 7/16" wrench, ratchet and 7/16" socket, and pliers.*

**The following photos are for assembly purposes, and please follow them from left to right, top to bottom.**



# ASSEMBLY

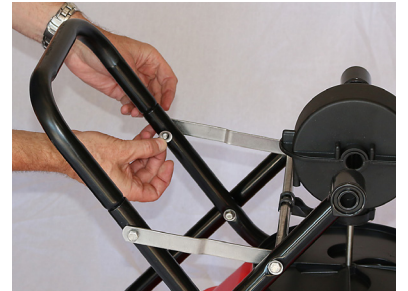
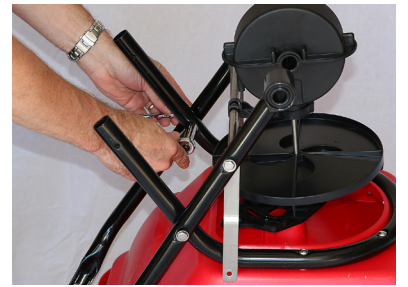
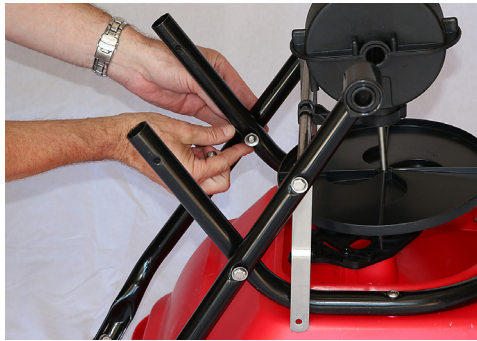
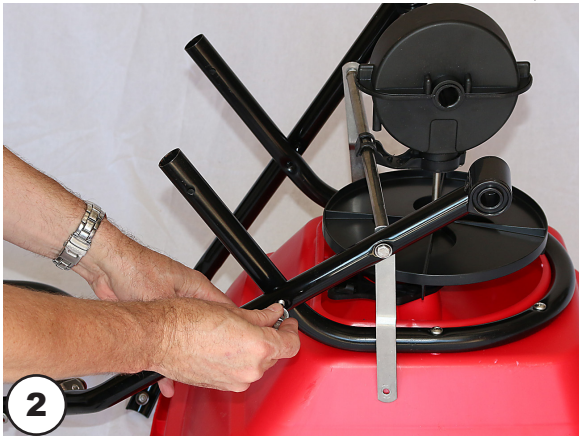
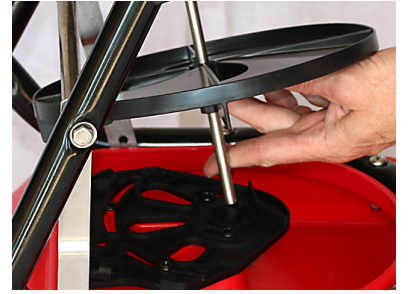

**ASSEMBLY - continued** 

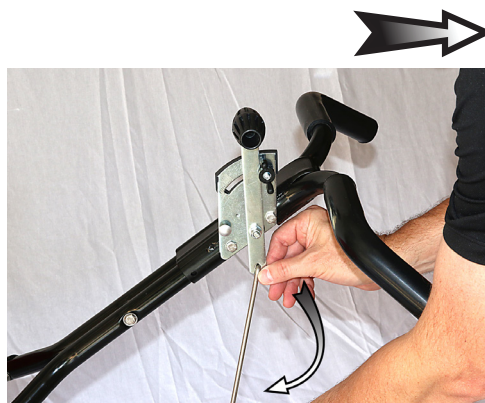
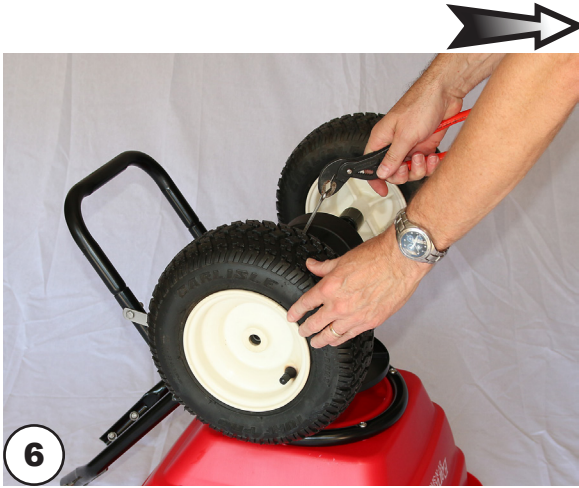

**ASSEMBLY - continued** →

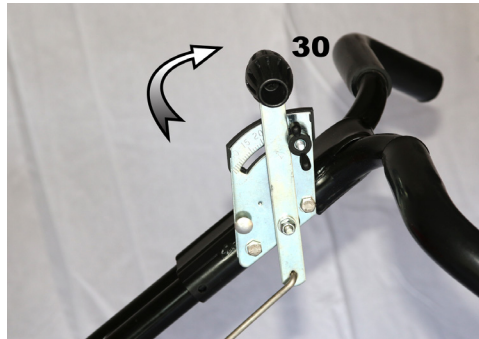

**CONFIRM THE CALIBRATION:**  
Lever at #30 and the drop holes fully open

**TO COMPLETE ASSEMBLY:**  
Install Agitator, bend the Agitator up slightly to prevent contact with the **STANDARD-OUTPUT** tray, and install debris screen.  
Press over 1/4 turn fasteners to secure.

**This only applies to the RED 3-hole drop STANDARD-OUTPUT Trays.**  
**The HIGH-OUTPUT (Blue) and LOW-OUTPUT (Black)Trays do not use the Agitator or Debris Screen shown below.**

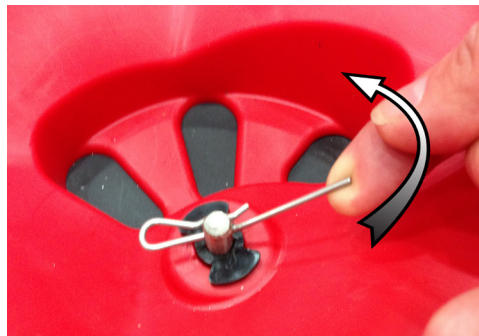

# TRAY INSTALLATION

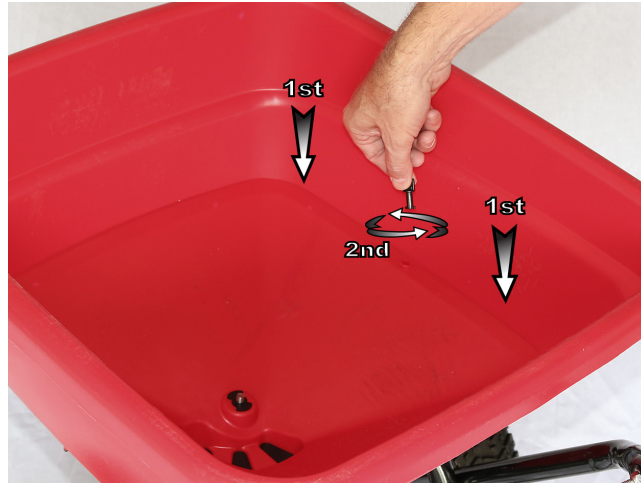

**HIGH-OUTPUT AND LOW-OUTPUT:**  
require the use of the Part #F12117



**No Agitator or Debris  
screen are included**



**HIGH-OUTPUT AND LOW-OUTPUT:**  
require the use of the Part #F12117



**No Agitator or Debris  
screen are included**



# Flex-Select®

## Setup and Calibration Techniques

### How to Install a Tray

First ensure the hopper is clean and there is no debris trapped around the tray mounting area. Secondly install the Pivot Rod Clip ① into the Shut-off of the selected Tray ③. Next, insert the Pivot Rod ② into the Clip ①. **TIP:** The Clip ① may have a burr in the hole, use a Phillips screwdriver to remove the burr. See ④ to make installing the Pivot Rod ② easier. Pliers may be required to help squeeze the Pivot Rod ② into the Clip ①. When the Rod ② is secure inside the Clip ① push the free end of the Clip ① over the Pivot Rod ② to firmly secure the rod to the clip. Next, install the Tray ③ from the top downwards into the hopper (see figure ⑤) positioning the center hole of the tray over the Pinion Shaft from the gear box with the Pivot Rod through the bottom of the hopper and facing toward the spreader's handlebar. For ease of locating into position the shut-off of the chosen tray is best in the open position, with the exception of the red **STANDARD-OUTPUT** Tray where the two adjustable throwing ports are best in the closed position.

**NOTE:** The gearbox can be moved along the axle to ease aligning of the tray hole and the pinion shaft. Once the tray is in place check that the tray is sealed and flush against the hopper sides. To check if the tray is properly located, push the tray edges downwards. Install the two quarter turn fasteners (see figure ⑥) through the two exposed tray holes and push down and twist a quarter turn to secure.

Lastly, connect the free end of the Pivot Rod ② into the Pivot linkage at the bottom of the Control Rod. Position the Clip ① into the free hole and push the Pivot Rod ② into the clip. **TIP:** The Clip ① may have a burr in the hole, use a Phillips screwdriver to remove the burr (see figure ④) When the Pivot Rod ② is positioned inside the Clip ① push the free end of the Clip ① over the Pivot Rod ② to firmly secure the rod and the clip together.

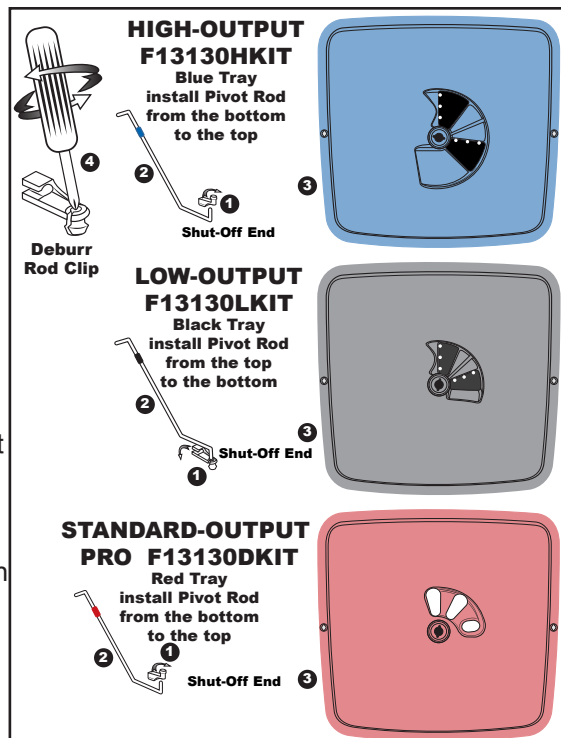

### How to ensure your spreader is properly calibrated

**HIGH-OUTPUT and LOW-OUTPUT Trays:** Make sure the drop holes in the bottom of the hopper are **FULLY CLOSED** when the Rate Control Lever is resting on the Stop #0. If the shut-off is not set correctly, please adjust Control Rod at the Pivot to position the shut-off for **FULLY CLOSED** at position at the Stop #0 on the Rate Control Lever. **As a side note, the HIGH-OUTPUT and LOW-OUTPUT Trays do not include or use a horizontal agitator.**

#### Calibration Adjustment

Review the Control Lever position to confirm that it is set so that the forward edge of the Lever is resting at #0 (the stop) and the drop holes are closed. Move the spreader back & forth to ensure that the cam is positioned to allow the Oscillating Shut-off to close fully. If the shut-off is not properly positioned, you will need to adjust the Control Rod at the Pivot Bracket shown below.

**TIP:** If your shut-off is not able to **CLOSE** fully, loosen the top nut a few turns, then tighten the lower nut so that it allows you to push the **shut-off fully closed**. Next, tighten each nut so that they contact the pivot bracket without moving it, and then carefully tighten each nut fully so they do not loosen during use. Recheck adjustment as outlined above.

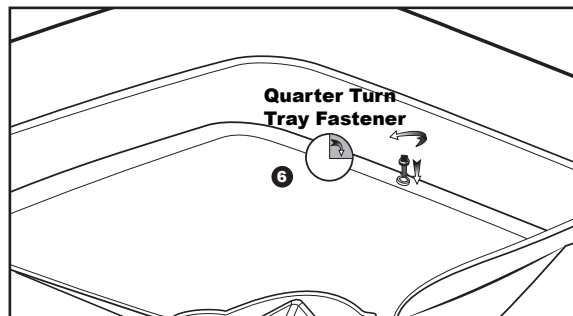
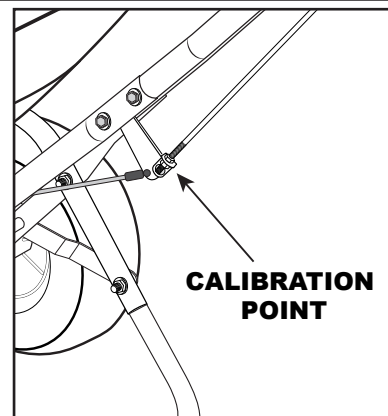

continued

## **How to ensure your spreader is properly calibrated** - continued

**STANDARD-OUTPUT Tray:** Make sure the drop holes in the bottom of the hopper are **FULLY OPEN** when the Rate Control handle is on #30. If the shut-off is not set correctly, please adjust Control Rod at the Pivot to position the shut-off for **FULLY OPEN** hopper position at #30 on the Rate Control Lever. Install the horizontal agitator through the pinion shaft in the hopper bottom. Finally, install the debris screen onto the Quarter-turn fasteners and push down to snap and secure.

### **Calibration Adjustment**

Review the Control Lever position to confirm that it is set so that the rear edge of the Lever is resting at #30 (the stop) and the drop holes are open. If the shut-off is not properly positioned, you will need to adjust the Control Rod at the Pivot Bracket shown below. **TIP:** If your shut-off is not able to **OPEN** fully, loosen the bottom nut a few turns, then tighten the upper nut so that it allows you to push the **shut-off fully open**. Next, tighten each nut so that they contact the pivot bracket without moving it, and then carefully tighten each nut fully so they do not loosen during use. Recheck adjustment as outlined above.

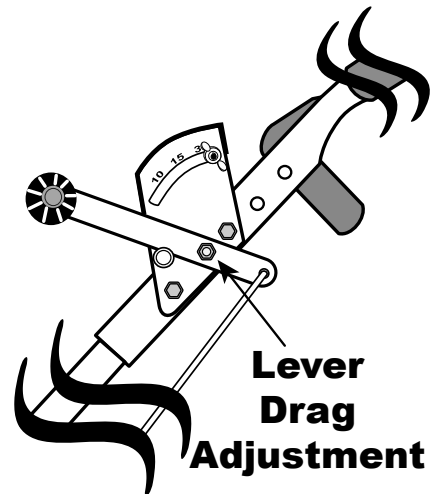
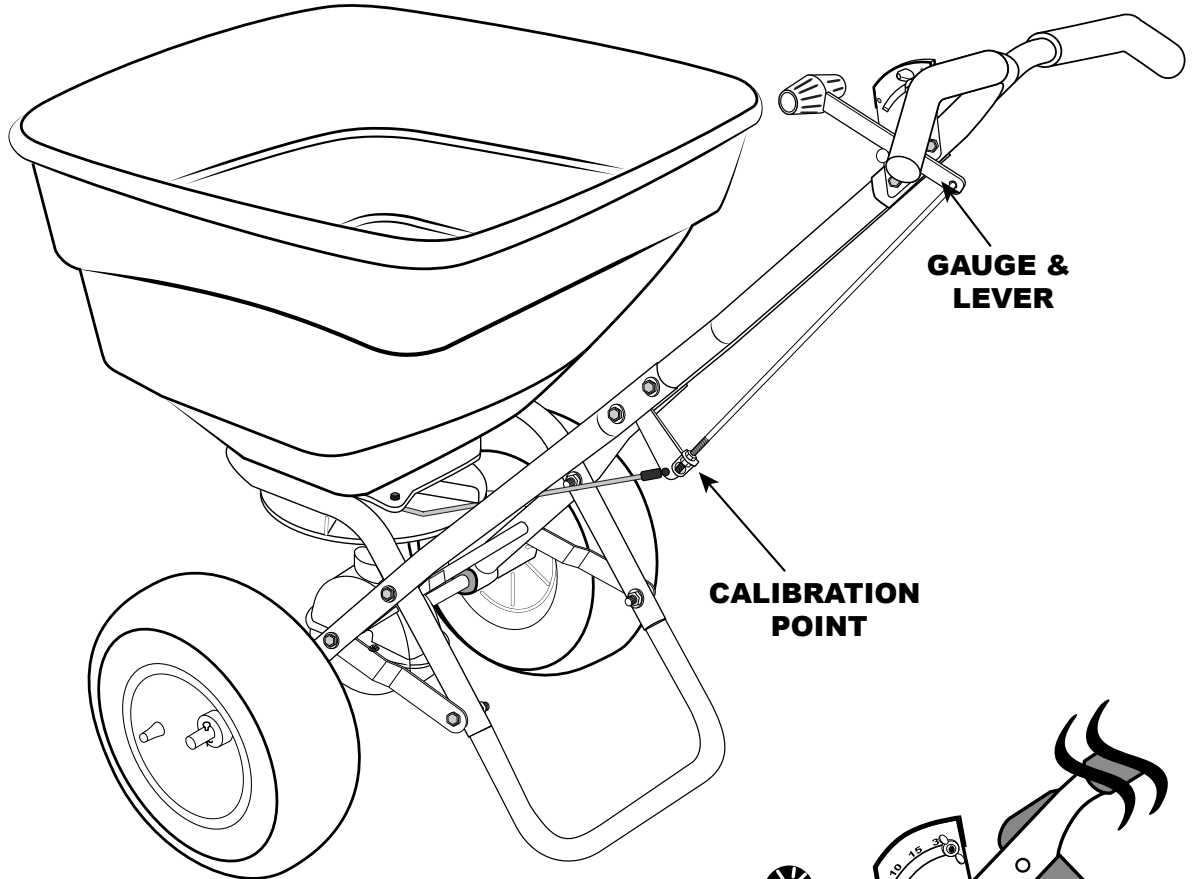
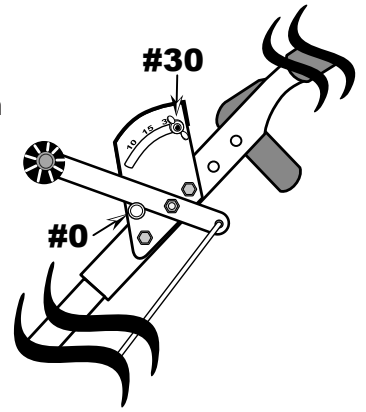

### **Control Lever Drag adjustment**

If the Control Lever does not stay in position causing the setting rate to change without your intervention, you can adjust the drag on the Lever by tightening or loosening the nut shown to the right until the drag is appropriate.

If you have any questions regarding the assembly or safe operation your spreader, please contact us at 800-294-0671 or 574-848-7491 Monday - Friday 9:00am - 4:00pm Eastern.

# Using the EV-N-SPRED® Dual Port PRO Adjustable Shut-Off System

The EV-N-SPRED® Dual Port PRO Adjustable Shut-Off System is included on all professional models and allows the operator to balance the spread pattern evenly across the full 180° spread width, regardless of the weight or size of granular material. By closing either the right and or left side throwing ports you can balance the spread pattern to exacting precision without compromising spread width or application rate.

Each EV-N-SPRED® Dual Port PRO Adjustable Shut-Off System drop hole has a corresponding 1/3<sup>rd</sup> coverage area on the spread width of the spreader leaving a feathered-edge for overlapping the spread path. The illustration to the right shows each port and the corresponding 1/3<sup>rd</sup> coverage area of the spread path. These ports can be adjusted to effectively balance the spread pattern, giving equal amounts of material across the full 180° spread pattern.

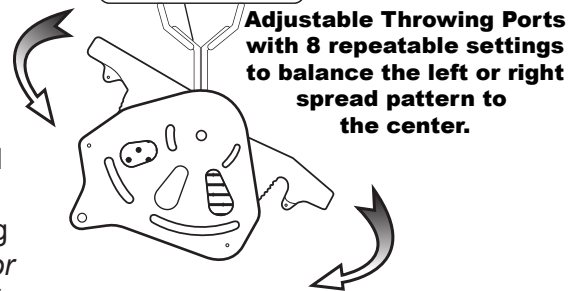
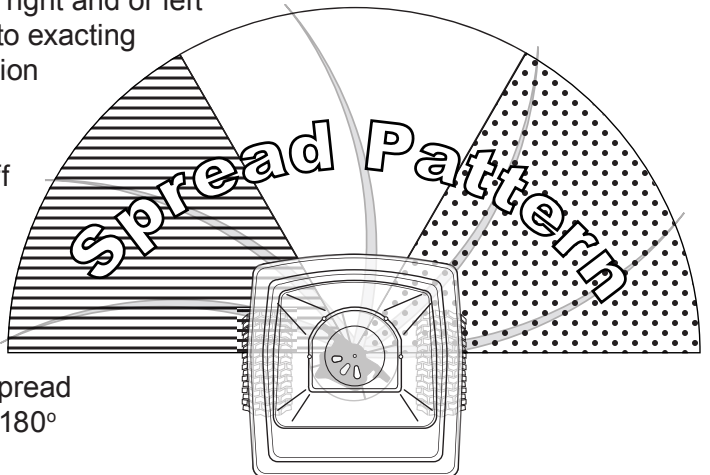

## EV-N-SPRED® Dual Port PRO System Setup

*Test all material prior to beginning your spreading job.* You will need a 50' measuring tape, a small scale to weigh the material, bucket or container to hold the material for re-weighing, chalk or a line marking device, and (7) low baking tins. *Using the EarthWay® Bag Calibrator #77016 can greatly reduce the time needed for determining the Setting Rates on any material but is not mandatory to establish a setting rate.*

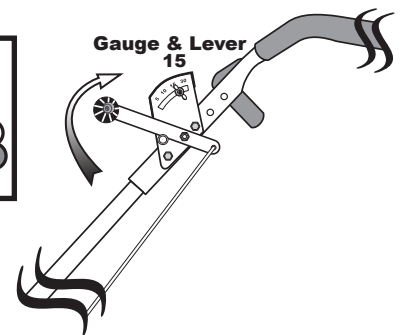
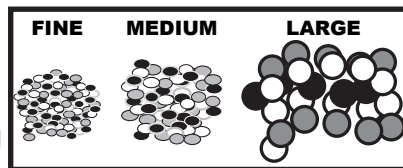

1. Evaluate the material being spread by comparing it to the following standard as a reference.

**Large/Heavy** is the size of a BB (1/8 in / 3mm), spread width is 28 - 36 feet (8.5 - 11 meters)

**Medium/Mixed** (1/2 the size of a BB), spread width is 20 - 24 feet (6.1 - 7.3 meters)

**Small/Fine** (the size of sand), spread width is 16 - 18 feet (4.8 - 5.5 meters)

2. Add a small amount of the material into the spreader, enough to cover the bottom (2-3 in / 5 - 7 cm) and begin to test for spread width.

Set the stop on the gauge to #15 and push the spreader several feet / meters at normal walking speed on a flat hard surface (where the material will be visible), and OPEN the lever to the STOP while continuing to walk for 3-4 paces, and CLOSE the shut-off and STOP (don't move the spreader from that position). Measure the spread width and evaluate the spread pattern for even distribution on either side of the spread width center line. **TIP:** Typical spread width references are listed above. *The spread width that you measure is used to calculate the actual Setting Rate for the material.*

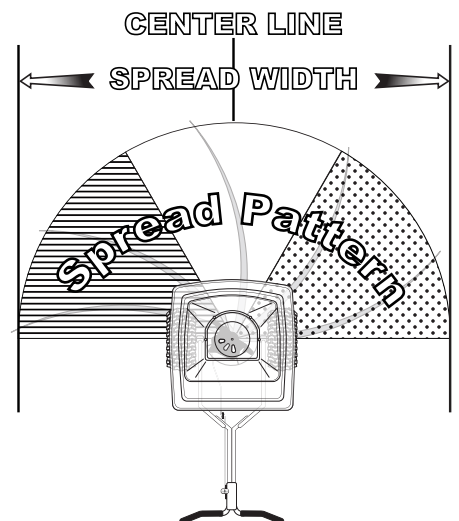



## ADJUSTING THE EV-N-SPRED® DUAL PORT SHUT-OFF SYSTEM

Next, using the (7) low baking tins position, them in a straight line on 2-foot centers across the spread width as shown at the right.

Adjust the left or right variable throwing ports to EVEN THE SPREAD pattern.

**TIP:** For large/heavy materials, close the **LEFT SIDE (LINES)** port slightly before you start your EV-N-SPRED® test. For small/light materials, open the **LEFT SIDE (LINES)** port fully and close the **RIGHT SIDE (CIRCLES)** port slightly before you start your EV-N-SPRED® test. With **BOTH** ports closed, the spread is only from the center port, and will give you a 3-4ft spread width in the center of the spreader - *great for medians*. Begin pushing the spreader several feet before the line of tins and at normal walking speed.

Walk along the Center Line, and **OPEN** the Lever to the **STOP** 3-4 paces before the line of tins and continue walking past the tins 1 or 2 paces and **CLOSE** the Lever and **STOP**.

Visually evaluate the material in the baking tins to determine if your spread pattern is balanced - *having the same amount of material in each baking tin*.

Empty each tin back into the spreader, adjust the ports and **RETEST** until you are satisfied that the coverage is balanced.

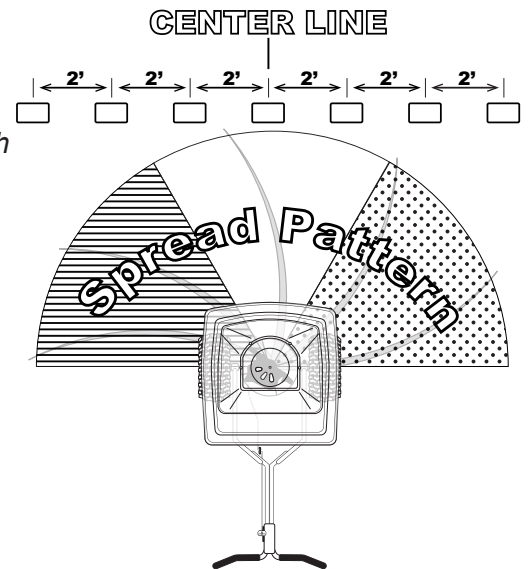
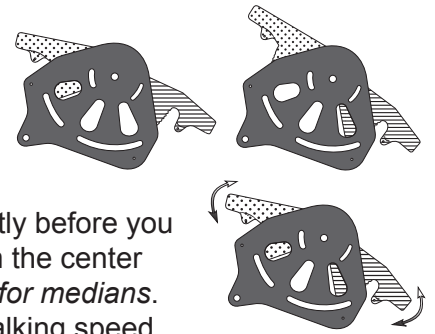

Spread width in feet	Length needed for 1,000 Sq Ft	Spread width in feet	Length needed for 1,000 Sq Ft	Spread width in feet	Length needed for 1,000 Sq Ft
7	142' 10"	17	58' 10"	27	37'
8	125'	18	55' 7"	28	35' 9"
9	111' 1"	19	52' 7"	29	34' 6"
10	100'	20	50'	30	33' 4"
11	90' 11"	21	47' 7"	31	32' 3"
12	83' 4"	22	45' 5"	32	31' 3"
13	76' 11"	23	43' 6"	33	30' 4"
14	71' 5"	24	41' 8"	34	29' 5"
15	66' 8"	25	40'	35	28' 7"
16	62' 6"	26	38' 6"	36	27' 9"

## ESTABLISH THE SETTING RATE

Remove the material from the hopper, and mark the distance that you need to travel with the spreader to attain the designated coverage area - i.e. 1,000 square feet using the spread width you determined earlier.

*Above is a chart to help determine the distance needed for 1,000 square foot calculation.*

Mark the **START** and **END POINTS** on the surface required for the test. Weigh a small amount (10-20lbs/4-9kg) of the material, and add that into to the spreader. Using the Setting Matrix included with the spreader, estimate a setting rate based on material manufacturers recommendations and adjust the **STOP** on the Gauge to that position.

Now to test, start walking 1-2 paces before the **START LINE** and **OPEN** the Lever to the stop and then **CLOSE** when you cross the **END POINT LINE**.

Pour the remaining material from the spreader and weigh to calculate the amount applied over the area. Adjust the **Setting Rate** to a higher number if you need to increase the application rate, or to a lower number if you applied too much in the test.

You may need to repeat this process to acquire the exact rate.

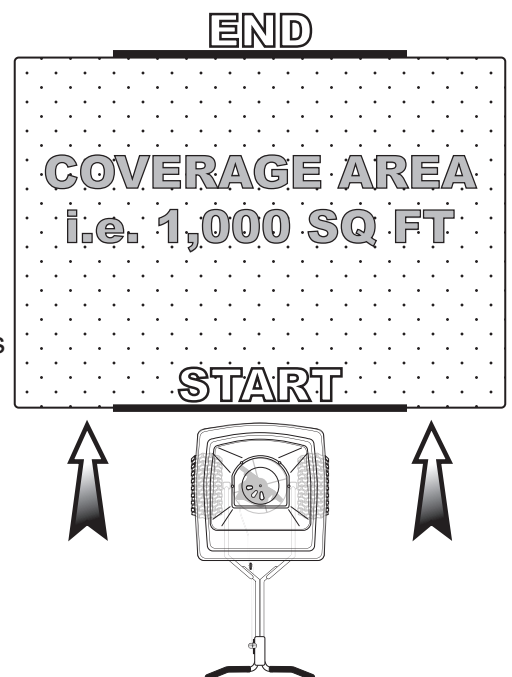

The EV-N-SPRED® Dual Port PRO Adjustable Shut-Off System ensures that EarthWay® Professional spreaders evenly spread all types of fertilizers, seed, ice melt, or other granular products, and is only available from EarthWay®.

# SPREAD PATH

## FULL Rate (one pass)

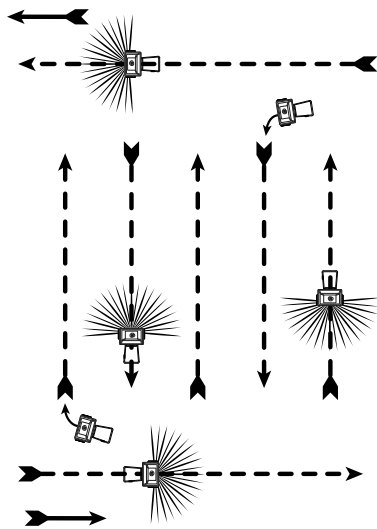

## HALF Rate (two passes)

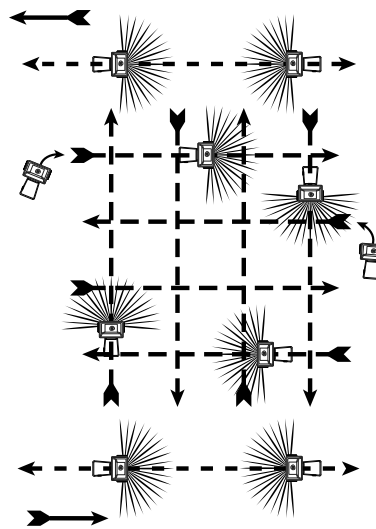

### 5-YEAR LIMITED WARRANTY

EPI warrants this product free of defects in original workmanship and materials for a period of 5-Years to the end user with the original purchase receipt. If a manufacturing non-conformance is found, EPI at its discretion will repair or replace the part(s) or product at no charge provided the failure is not the result of incorrect installation, mishandling, misuse, tampering, or normal wear and tear as determined by EPI. EPI at its discretion may require that the part(s) or product be returned along with the original purchase receipt at owners' expense for examination and compliance with the terms of this warranty. Do not return any product without first receiving authorization from EPI. To seek remedy under this warranty, contact EPI at 574-848-7491, or write to EPI P.O. Box 547 Bristol, Indiana 46507 and describe the nature of the manufacturing defect. **SPECIFIC**

**LIMITATIONS:** This warranty covers only the part(s) or product; any labor charges associated with repair or replacement of non-conformances are specifically excluded. Due to the corrosive nature of most fertilizers and ice melt products, EPI makes no warranty against and specifically excludes part(s) or product degradation or failure due to corrosion or its effects. Clean and dry your spreader thoroughly after each use, as a preventative measure, coat all metal parts with a light oil or silicon spray.

### OPERATING INSTRUCTIONS

Before filling hopper, become familiar with the operation of this spreader.

- Obtain proper setting for material to be used from the enclosed SETTING MATRIX included with this spreader, or from our web site under the MANUALS SECTION.
- Move stop bolt on rate gauge assembly to the proper setting.
- While pushing spreader forward, pull control lever back to stop bolt.
- To stop, push lever forward to close flow holes before you stop moving.
- When finished, empty any remaining material from hopper.
- Thoroughly wash spreader and allow to dry before storing. Apply coating of light oil to help prevent corrosion.
- If you use Rock Salt, **remove agitator** when using Rock Salt to prevent damage to the gearbox.

EPI  
1009 Maple Street, PO Box 547  
Bristol, IN 46507

For Your Records

\_\_\_\_\_

Date Purchased

\_\_\_\_\_

Place of Purchase

### HOW TO ORDER SPARE PARTS

All spare parts listed may be ordered direct from  
EPI

Be sure to give the following information when ordering.

**Model Number**

**Part Number**

**Part Description**

Call (574) 848-7491

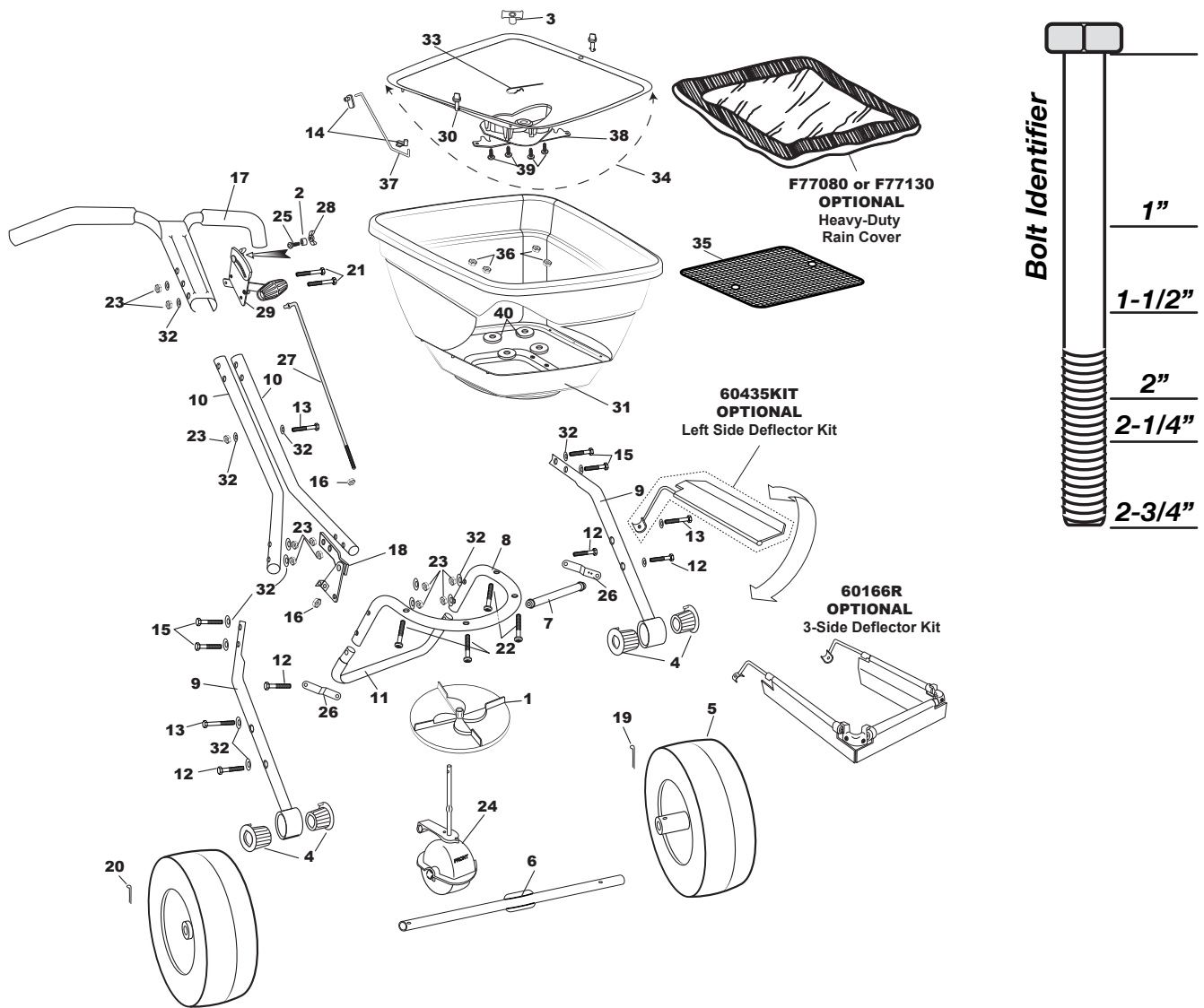

## F80P & F130P Series Professional Broadcast Spreader

Key #	Part #	Description	Key #	Part #	Description
1	12110	IMPELLER 9" ROUND DISHED	23	32103	1/4-20 NYLON INS LOCKNUT ZINC
2	12147	SPACER (PIVOT LINK)	24	F60333	GEAR BOX ASSEMBLY FLEX -SELECT
3	12209	HOPPER BUSHING	25	37100	1/4-20 X 1" CARRIAGE BOLT ZINC
4	12352	BEARING (COMMERCIAL) EACH	26	42237	FRAME BRACE
5	19117	13" DIA PNEU TIRE DRIVE	27	42256	CONTROL ROD
6	24500	AXLE, COINED	28	60027	WING NUT ASSEMBLY BLACK
7	24704	CROSS BRACE (11.125")	29	60298	GAUGE & LEVER ASSEMBLY
8	25108	FRAME	30	F12135	1/4 TURN FASTENER FLEX SELECT
9	25202	LOWER HANDLE COMPLETE	31	FLEX-SELECT 80# HOPPER (F13105) 130# HOPPER (F13106)	
10	25301	HANDLE SHAFT	32	36404	1/4 CUPPED WASHER S.S.
11	25723	FRAME Foot (Flex-Select Painted)	33	33117	AGITATOR
12	31100	1/4-20 X 1 1/2 HHMS ZINC	34	F13130D	STANDARD OUTPUT DUAL PORT PRO FLEX-SELECT TRAY KIT
13	31106	1/4-20 X 2 1/4" HHCS ZINC	35	F40003	SQUARE SCREEN FLEX-SELECT
14	31127	ROD CLIP (Flex-Select)	36	36300	1/4-20 NYLON INSERT LOCKNUT S.S.
15	31114	1/4-20 X 1 3/4" HHCS ZINC	37	F44251	PIVOT ROD STD OUTPUT FLEX-SELECT
16	36305	1/4-20 HEX NUT STAINLESS STEEL	38	F12219D	DUAL PORT PRO FLEX-SELECT SHUTOFF ASSEMBLY
17	60069	UPPER HANDLE ASSEMBLY W/GRIPS	39	31138	#8 X 3/8" PMT #8 HD COARSE BLACK
18	60299	PIVOT & BRACKET ASSEMBLY	40	43020	BACKPLATE WASHER
19	36103	3/16 X 2" COTTER PIN S.S.	Optional	60435KIT	SIDE DEFLECTOR
20	36104	3/16 X 1" COTTER PIN S.S.	Optional	HEAVY DUTY RAIN COVER (F77080 for F80 / F77130 FOR F130)	
21	31107	1/4-20 X 2 3/4" HHCS ZINC	Optional	12195	GAUGE OVERLAY- LESCO SETTINGS
22	36214	1/4-20 X 1 1/2" PHPMS S.S.	Standard	12196RT	GAUGE OVERLAY- RT

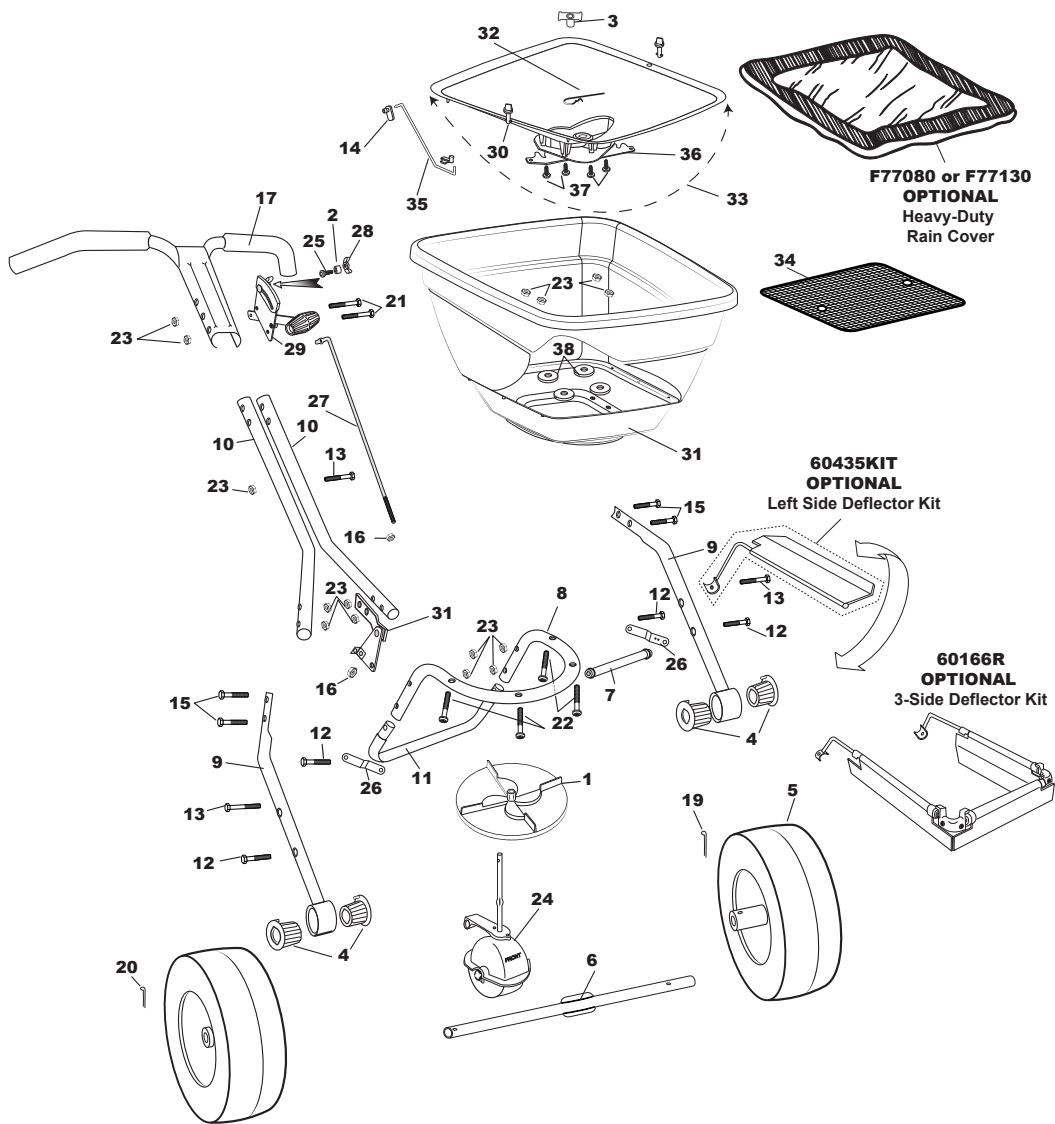

## F80PS & F130PS Series Professional Broadcast Spreader

Key #	Part #	Description	Key #	Part #	Description
1	12110	IMPELLER 9" ROUND DISHED	22	36214	1/4-20 X 1 1/2" PHPMS S.S.
2	12147	SPACER (PIVOT LINK)	23	36300	1/4-20 NYLON INSERT LOCKNUT S.S.
3	12209	HOPPER BUSHING	24	F60333	GEAR BOX ASSEMBLY FLEX -SELECT
4	12352	BEARING (COMMERCIAL) EACH	25	37100	1/4-20 X 1" CARRIAGE BOLT ZINC
5	19117	13" DIA PNEU TIRE DRIVE	26	42237	FRAME BRACE
6	24500	AXLE, COINED	27	42256	CONTROL ROD
7	24704	CROSS BRACE (11.125")	28	60027	WING NUT ASSEMBLY BLACK
8	24111	FRAME	29	60298	GAUGE & LEVER ASSEMBLY
9	24202	LOWER HANDLE COMPLETE	30	F12135	1/4 TURN FASTENER FLEX SELECT
10	24300	HANDLE SHAFT	31	FLEX-SELECT 80# HOPPER (F13105) 130# HOPPER (F13106)	
11	25723-SS	FRAME FOOT SS	32	33117	AGITATOR
12	36200	1/4-20 X 1 1/2" HHCS S.S.	33	F13130D	STANDARD OUTPUT DUAL PORT PRO FLEX-SELECT TRAY KIT
13	36205	1/4-20 X 2 1/4" HHCS S.S.	34	F40003	SQUARE SCREEN FLEX-SELECT
14	31127	ROD CLIP (Flex-Select)	35	F44251	PIVOT ROD STD OUTPUT FLEX-SELECT
15	36209	1/4-20 X 1 3/4" HHCS S.S.	36	F12219D	DUAL PORT PRO FLEX-SELECT SHUTOFF ASSEMBLY
16	36305	1/4-20 HEX NUT STAINLESS STEEL	37	31138	#8 X 3/8" PMT #8 HD COARSE BLACK
17	60070	UPPER HANDLE ASSEMBLY W/GRIPS	38	43020	BACKPLATE WASHER
18	60299	PIVOT & BRACKET ASSEMBLY			
19	36103	3/16 X 2" COTTER PIN S.S.	Optional	60435KIT	SIDE DEFLECTOR
20	36104	3/16 X 1" COTTER PIN S.S.	Optional	HEAVY DUTY RAIN COVER (F77080 for F80 / F77130 FOR F130)	
21	36207	1/4-20 X 2 3/4" HHCS S.S.	Optional	12195	GAUGE OVERLAY- LESCO SETTINGS
22	36214	1/4-20 X 1 1/2" PHPMS S.S.	Standard	12196RT	GAUGE OVERLAY- RT

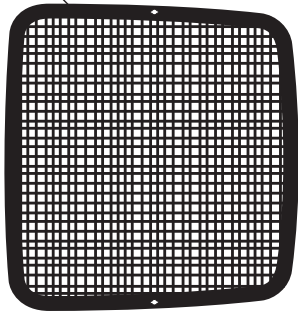

**F40003 DEBRIS SCREEN**  
Included with both  
**STANDARD-OUTPUT**  
Trays only

### STANDARD-OUTPUT F13130KIT

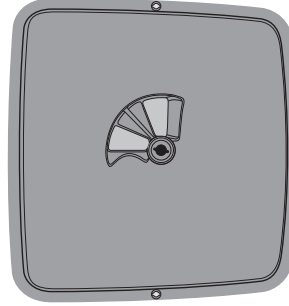
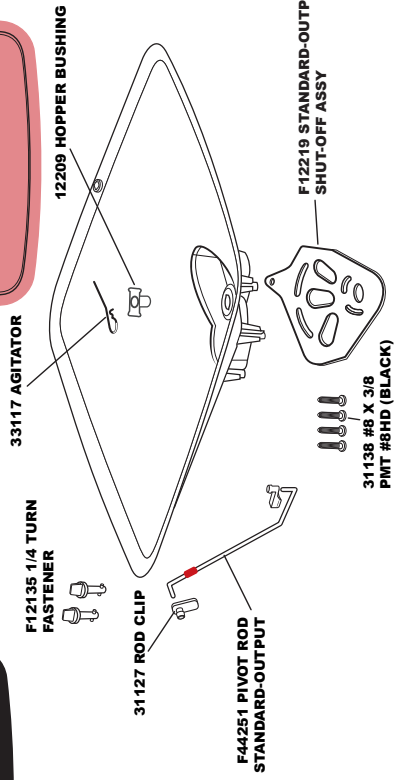

### LOW-OUTPUT F13130LKIT

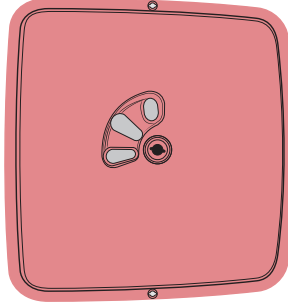
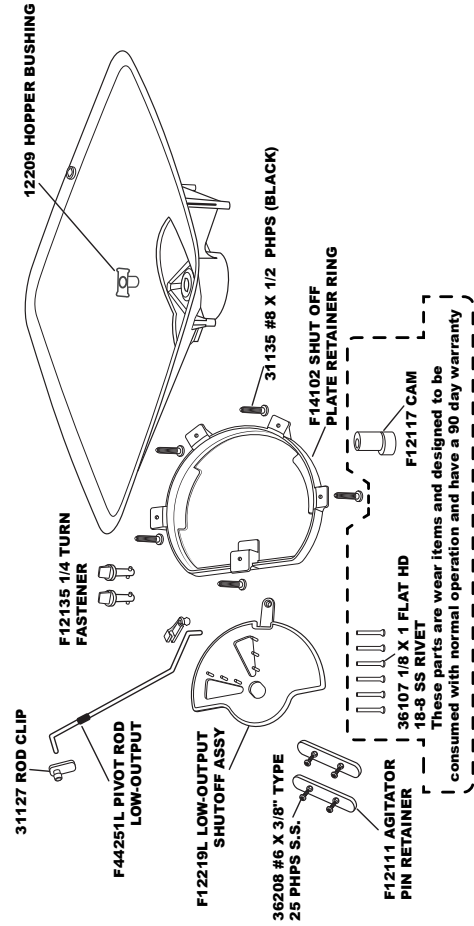

### STANDARD-OUTPUT PRO F13130DKIT

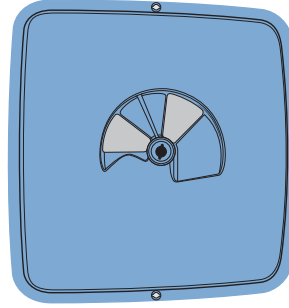
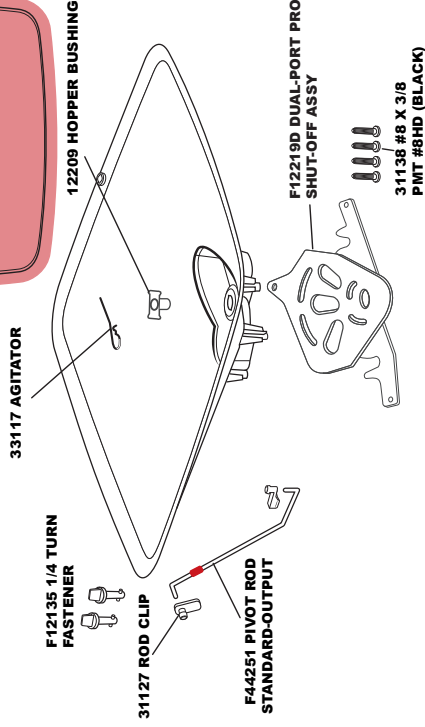



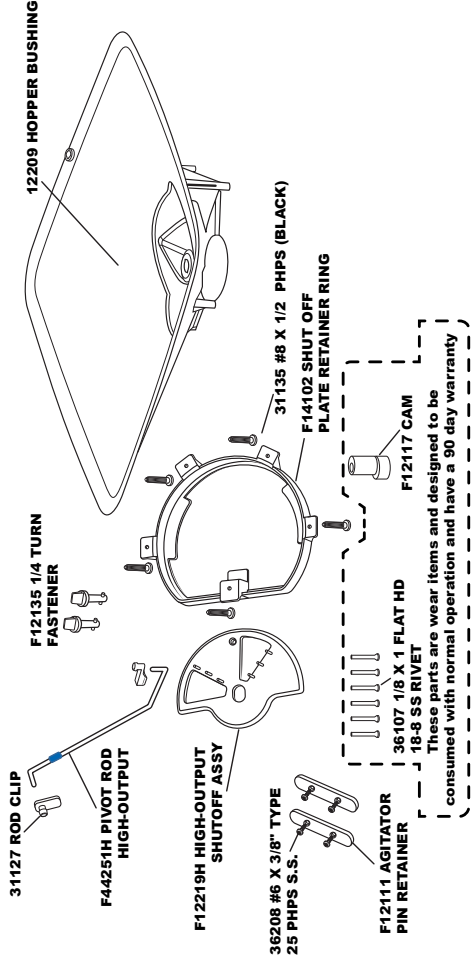

### HIGH-OUTPUT F13130HKIT



# FLEX-SELECT® BROADCAST SPREADER SETTING MATRIX

## GRANULAR MATERIAL





<b>Standard-Output Red Tray</b>												
PARTICLE SIZES: Fine/Small → (SAND)  Medium → (HALF BB)  Large → (BB)  EXTRA LARGE → ROCK SALT 												
Grams PER Square Meter	SETTING	SPREAD WIDTH FT	SPREAD METERS	SETTING	SPREAD WIDTH FT	SPREAD METERS	SETTING	SPREAD WIDTH FT	SPREAD METERS	SETTING	SPREAD WIDTH FT	SPREAD METERS
5	7	18	5.5	9	24	7.3	14	36	11.0	17	37	11.3
10	10	18	5.5	13	24	7.3	18	36	11.0	22	37	11.3
15	13	18	5.5	16	24	7.3	23	36	11.0	24	37	11.3
20	14	18	5.5	20	24	7.3	27	36	11.0	26	37	11.3
24	16	18	5.5	22	24	7.3	30	36	11.0	28	37	11.3
29	18	18	5.5	25	24	7.3	23 x 2 pass	36	11.0	29	37	11.3
34	20	18	5.5	27	24	7.3	25 x 2 pass	36	11.0	30	37	11.3
39	22	18	5.5	28	24	7.3	27 x 2 pass	36	11.0	26 x 2 pass	37	11.3
44	24	18	5.5	30	24	7.3	28 x 2 pass	36	11.0	27 x 2 pass	37	11.3
49	26	18	5.5	22 x 2 pass	24	7.3	30 x 2 pass	36	11.0	28 x 2 pass	37	11.3

## GRASS SEED

Grams PER Square Meter	FINE SETTING	SPREAD WIDTH FT	SPREAD METERS	COARSE SETTING	SPREAD WIDTH FT	SPREAD METERS
10	14	8	2.4	22	14	4.3
15	16	8	2.4	25	14	4.3
20	18	8	2.4	28	14	4.3
25	20	8	2.4	30	14	4.3

**Calibration:** Start by ensuring that your spreader calibration is correct. Make sure the drop holes in the **Standard-Output Tray** are fully open when the Rate Control handle is on #30. If not, please adjust control rod at the pivot to allow for a full open hopper holes with the handle at position at #30.

## GRANULAR MATERIAL





<b>Low-Output Black Tray</b>												
PARTICLE SIZES: Fine/Small → (SAND)  Medium → (HALF BB)  Large → (BB)  EXTRA LARGE → ROCK SALT 												
Grams PER Square Meter	SETTING	SPREAD WIDTH FT	SPREAD METERS	SETTING	SPREAD WIDTH FT	SPREAD METERS	SETTING	SPREAD WIDTH FT	SPREAD METERS	SETTING	SPREAD WIDTH FT	SPREAD METERS
5	8	16	4.9	10	20	6.1	15	30	9.1	18	24	7.3
10	10	16	4.9	13	20	6.1	18	30	9.1	20	24	7.3
15	12	16	4.9	18	20	6.1	23	30	9.1	25	24	7.3
20	13	16	4.9	20	20	6.1	28	30	9.1	27	24	7.3
24	16	16	4.9	22	20	6.1	30	30	9.1	30	24	7.3
29	18	16	4.9	25	20	6.1	23 x 2 pass	30	9.1	25 x 2 pass	24	7.3
34	20	16	4.9	27	20	6.1	25 x 2 pass	30	9.1	26 x 2 pass	24	7.3
39	21	16	4.9	29	20	6.1	28 x 2 pass	30	9.1	27 x 2 pass	24	7.3
44	23	16	4.9	30	20	6.1	29 x 2 pass	30	9.1	29 x 2 pass	24	7.3
49	24	16	4.9	22 x 2 pass	20	6.1	30 x 2 pass	30	9.1	30 x 2 pass	24	7.3

## GRASS SEED

Grams PER Square Meter	FINE SETTING	SPREAD WIDTH FT	SPREAD METERS	COARSE SETTING	SPREAD WIDTH FT	SPREAD METERS
10	15	9	2.7	21	15	4.6
15	18	9	2.7	24	15	4.6
20	21	9	2.7	27	15	4.6
25	24	9	2.7	30	15	4.6

**Calibration:** Start by ensuring that your spreader calibration is correct. Make sure the drop holes in the **LOW-OUTPUT TRAY** are fully closed when the Rate Control Handle is resting on the **stop #0**. If not, please adjust control rod at the pivot to ensure the shut-off is fully closed with the handle at position at #0. Move the spreader slightly to confirm the calibration because of the cam.

## GRANULAR MATERIAL

<b>High-Output Blue Tray</b>												
PARTICLE SIZES: Fine/Small → (SAND)  Medium → (HALF BB)  Large → (BB)  EXTRA LARGE → ROCK SALT 												
Grams PER Square Meter	SETTING	SPREAD WIDTH FT	SPREAD METERS	SETTING	SPREAD WIDTH FT	SPREAD METERS	SETTING	SPREAD WIDTH FT	SPREAD METERS	SETTING	SPREAD WIDTH FT	SPREAD METERS
5	3	16	4.9	5	22	6.7	7	28	8.5	8	26	7.9
10	5	16	4.9	6	22	6.7	10	28	8.5	11	26	7.9
15	6	16	4.9	8	22	6.7	12	28	8.5	13	26	7.9
20	7	16	4.9	9	22	6.7	14	28	8.5	14	26	7.9
24	8	16	4.9	11	22	6.7	15	28	8.5	15	26	7.9
29	10	16	4.9	13	22	6.7	17	28	8.5	16	26	7.9
34	11	16	4.9	15	22	6.7	20	28	8.5	17	26	7.9
39	12	16	4.9	16	22	6.7	21	28	8.5	18	26	7.9
44	13	16	4.9	17	22	6.7	23	28	8.5	19	26	7.9
49	14	16	4.9	18	22	6.7	24	28	8.5	21	26	7.9

## GRASS SEED

Grams PER Square Meter	FINE SETTING	SPREAD WIDTH FT	SPREAD METERS	COARSE SETTING	SPREAD WIDTH FT	SPREAD METERS
10	7	10	3.0	11	15	4.6
15	9	10	3.0	14	15	4.6
20	11	10	3.0	16	15	4.6
25	13	10	3.0	18	15	4.6

**Calibration:** Start by ensuring that your spreader calibration is correct. Make sure the drop holes in the **HIGH-OUTPUT TRAY** are fully closed when the Rate Control Handle is resting on the **stop #0**. If not, please adjust control rod at the pivot to ensure the shut-off is fully closed with the handle at position at #0. Move the spreader slightly to confirm the calibration because of