

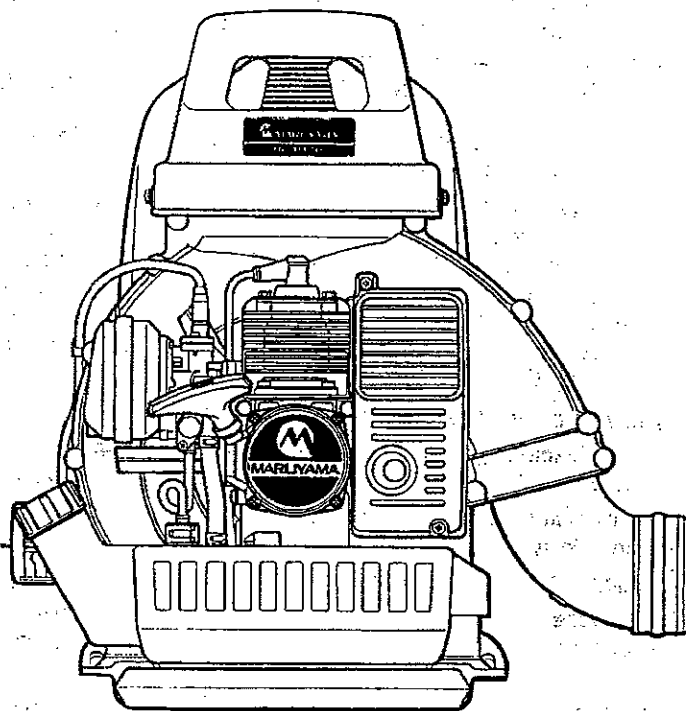

BL4000 / BL4800



Owner's / Operator's Manual

Completely read and understand this manual before using this product.



Limited Warranty Statement

All Maruyama products are warranted to the original purchaser to be free from defects in material and workmanship **from the date of purchase** for the time periods listed as follows:

Lifetime for inner drive shafts on trimmers and brushcutters and all ignition modules. **3 years** for residential, non-institutional, non-income producing use. **2 years** for industrial, commercial, institutional and income producing use. **1 year** for rental use.

Any part of a Maruyama product found to be defective within the applicable warranty period shall, at Maruyama's option, be repaired or replaced without charge. Warranty consideration is obtained by delivering any Maruyama product believed to be defective to an Authorized Maruyama Servicing Dealer within the applicable warranty period.

The purchaser shall not be charged for diagnostic labor that leads to the determination that a warranted part is defective, if the diagnostic work is performed at a Maruyama Dealer.

Any warranted part which is not scheduled for replacement as required maintenance, or which is scheduled only for regular inspection to the effect of "repair or replace as necessary" shall be warranted for the warranty period. Any warranted part which is scheduled for replacement as required maintenance shall be warranted for the period of time up to the first scheduled replacement point for that part. Maruyama Mfg. Co., Inc. is liable for damages to other engine components caused by the failure of a warranted part still under warranty.

The purchaser is responsible for the performance of the required maintenance, as defined by Maruyama Mfg. Co., Inc. in the Owner's/Operator's Manual.

EMISSION-RELATED PARTS WARRANTY : In addition to the above warranty coverage, Maruyama Mfg. Co., Inc. will repair or replace, free of charge, for the original purchaser and each subsequent purchaser any emission-related part or parts found to be defective in material and workmanship for two (2) years from original retail delivery date. **Emission-related parts are the carburetor assembly, the ignition coil assembly, the ignition rotor and the spark plug.** Any replacement part that is equivalent in performance and durability may be used in non-warranty maintenance or repairs, and shall not reduce the warranty obligations of Maruyama Mfg. Co., Inc.

This warranty does not cover the following :

1. Maintenance items (excluding defects in materials and workmanship) including hoses, spark plugs, starter rope, air and fuel filters, vibration isolators, throttle cables and all cutting attachments.
2. Extra expenses including shipping and handling, travel, payment for lost time or pay and for any inconvenience and storage.
3. Alterations or modifications including aftermarket parts not authorized by Maruyama U.S., Inc.
4. Wear, accident, abuse, neglect, misuse, negligence, improper fuels, lubricants, fuel mixtures (when applicable), or failure to operate or maintain the product in accordance with instructions approved by Maruyama.

Repair or replacement as provided under this warranty is the exclusive remedy of the consumer. Maruyama shall not be liable for any incidental or consequential damages for breach of any express or implied warranty on these products except to the extent prohibited by applicable law. Any implied warranty of merchantability or fitness for a particular purpose on these products is limited in duration to the warranty period as defined in the limited warranty statement. Maruyama reserves the right to change or improve the design of the product without notice and does not assume obligation to update previously manufactured products.

This warranty provides you with specific legal rights which may vary from state to state.

It is the Owner's and Dealer's responsibility to make sure the Warranty Registration Card is properly filled out and mailed to Maruyama U.S., Inc. Proof of purchase and registration will be required in order to obtain warranty service.

To locate an Authorized Maruyama Servicing Dealer nearest you, contact Maruyama U.S., Inc. at **1-253-735-7368.**

Maruyama U.S., Inc.
PO Box 309
Auburn, WA 98071-0309

WARNING
The engine exhaust from this product contains chemicals known to the State of California to cause cancer, birth defects or other reproductive harm.

CALIFORNIA EMISSION CONTROL WARRANTY STATEMENT YOUR WARRANTY RIGHTS AND OBLIGATIONS

The California Air Resources Board and Maruyama Manufacturing Company, Inc. is pleased to explain the emission control system warranty on your 1995 and later lawn and garden equipment engine. In California, new utility and lawn and garden equipment engines must be designed, built and equipped to meet the State's stringent anti-smog standards. Maruyama Manufacturing Company, Inc. must warrant the emission control system on your lawn and garden equipment engine for the periods of time listed below provided there has been no abuse, neglect or improper maintenance of your lawn and garden equipment engine.

Your emission control system may include parts such as the carburetor or fuel-injection system, the ignition system, and catalytic converter. Also included may be hoses, belts, connectors and other emission-related assemblies.

Where a warrantable condition exists, Maruyama Manufacturing Company, Inc. will repair your lawn and garden equipment engine at no cost to you including diagnosis, parts and labor.

MANUFACTURER'S WARRANTY COVERAGE:

The 1995 and later utility and lawn and garden equipment engines are warranted for two years. If any emission-related part on your engine is defective, the part will be repaired or replaced by Maruyama Manufacturing Company, Inc.

OWNER'S WARRANTY RESPONSIBILITIES:

- As the lawn and garden equipment engine owner, you are responsible for the performance of the **required maintenance listed in your owner's manual**. Maruyama Manufacturing Company, Inc. recommends that you retain all receipts covering maintenance on your lawn and garden equipment engine, but Maruyama Manufacturing Company, Inc. cannot deny warranty solely for the lack of receipts or for your failure to ensure the performance of all scheduled maintenance.
- As the lawn and garden equipment engine owner, you should however be aware that Maruyama Manufacturing Company, Incorporated may deny you warranty coverage if your lawn and garden equipment engine or a part has failed due to abuse, neglect, improper maintenance or unapproved modifications.
- You are responsible for presenting your lawn and garden equipment engine to a Maruyama Manufacturing Company, Inc. distribution center as soon as a problem exists. The warranty repairs should be completed in a reasonable amount of time, not to exceed 30 days.

If you have any questions regarding your warranty rights and responsibilities, you should contact Maruyama U.S., Inc. at 1-253-735-7368.

FOREWORD

This Owner's/Operator's Manual is designed to familiarize the operator with the various features and component parts of the equipment and to assist you with the assembly, operation and maintenance of your new Backpack Blower.

It is essential that any operator of this Backpack Blower product reads and understands the contents of this manual before using the Backpack Blower.

Important safety instructions will be identified by the following safety symbol:



Failure to comply with the instructions in this manual may result in serious injury or death. For additional assistance, contact any local authorized Maruyama dealer or Maruyama U.S., Inc., 15436 N.E. 95th St., Redmond, WA 98073 – 2167

TABLE OF CONTENTS

Warranty	1	Before operation	6
Foreword	3	Operating Instructions	8
Specifications	3	Regular maintenance	9
Safety instructions	4	Storage	11
Assembly instructions	5		

SPECIFICATIONS

Model	BL4000	BL4800
Dimensions L × W × H	322 × 577 × 515mm (12.7 × 22.7 × 20.3 in.)	322 × 558 × 530mm (12.7 × 22.0 × 20.9 in.)
Dry Weight	8.6kg (19.0 lbs)	9kg (19.8 lbs)
Engine Type	KAWASAKI/2-Stroke, Air cooled	
	TE40	TE48
Displacement	40.2cc	48.7cc
Ignition System	Electric	
Carburetor	Pulse pump	
Fuel Tank Capacity	1.2 lit (1.3qts)	2.0 lit (2.1 qts)
Fuel Mixture Using Maruyama 50:1 2-cycle engine oil or any quality 2-cycle engine oil designed for use in air-cooled, high perform- ance 2-cycle engines.	50:1	
Attachments (Standard)	Four Section Pipe, W/Fan-blower Head	



WARNING



1. Read and understand this Owner's / Operator's Manual before using the power blower. Be thoroughly familiar with the proper use of the power blower.
2. Never allow children to operate the power blower. It is not a toy. Never allow adults to operate the unit without first reading the Owner's / Operator's Manual.
3. Become familiar with the controls and know how to stop the engine quickly.
4. Always use eye protection and hearing protection.
5. Keep the area of operation clear of all persons, particularly small children and pets.
6. Never operate a power blower when you are fatigued.
7. Never operate a power blower without proper guards or other protective safety devices in place.
8. Dress properly; do not wear loose clothing or jewelry that can be caught in moving parts. Always wear substantial footwear, long pants, and long sleeved shirt.
9. Gasoline is highly flammable; handle it carefully.
 - A. Do not smoke while handling gasoline.
 - B. Use an approved fuel container for storing the gasoline/oil mixture.
 - C. Do not fill the fuel tank when the engine is hot or running.
 - D. Fill the fuel tank outdoors and only up to one-half inch from the top of the tank. Do not fill the filler neck.
 - E. Wipe away any spilled gasoline before starting the engine.
10. Always be sure of your footing; keep a firm hold of the blower pipes, and walk, never run while operating a power blower.
11. Use the correct accessories. Do not use the power blower for any job except that for which it is intended.
12. Keep all fasteners tight and be sure the power blower is in safe working condition. Follow the maintenance instructions provided on page 8—10 of this manual.
13. Do not put hands or feet near or under the rotating parts. Keep clear at all times.
14. If the power blower should start to vibrate abnormally, stop the engine immediately and check for the cause. Vibration is generally a warning of trouble.
15. Avoid using the power blower near rocks, gravel, stones and similar matter in order to avoid dangerous flying debris.
16. Use the power blower only in daylight or good artificial light.

The MARUYAMA BACKPACK POWER BLOWER comes with an Owner's / Operator's Manual and a Warranty Registration Card. Assembly and attachment of the throttle lever bracket and blower pipes are required.

ASSEMBLY INSTRUCTIONS

STEP #1) Locate and identify all the components(see sketch).

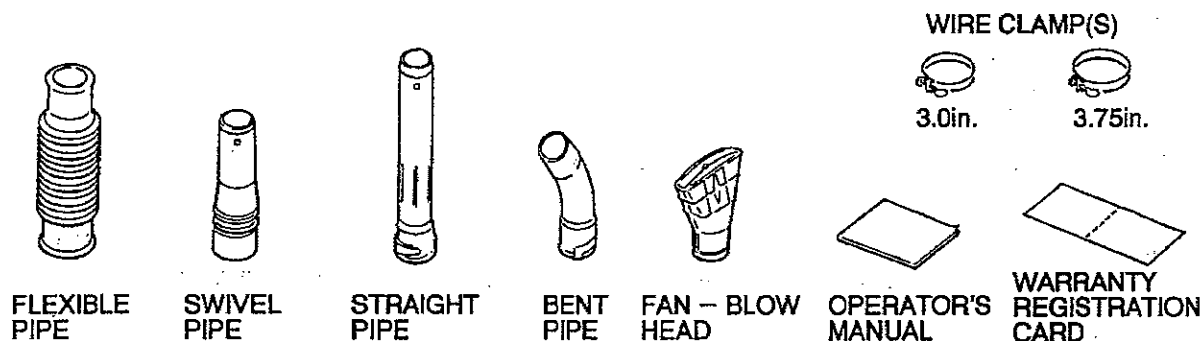

STEP #2) Using the WIRE CLAMPS, connect the FLEXIBLE PIPE to the blower, and the SWIVEL PIPE to the flexible pipe (see sketch below).

STEP #3) Assemble the STRAIGHT PIPE, BENT PIPE, and FAN-BLOW HEAD, then connect them to the swivel pipe(see sketch below).

STEP #4) Attach the throttle lever bracket to the blower housing (see instructions on page 6).

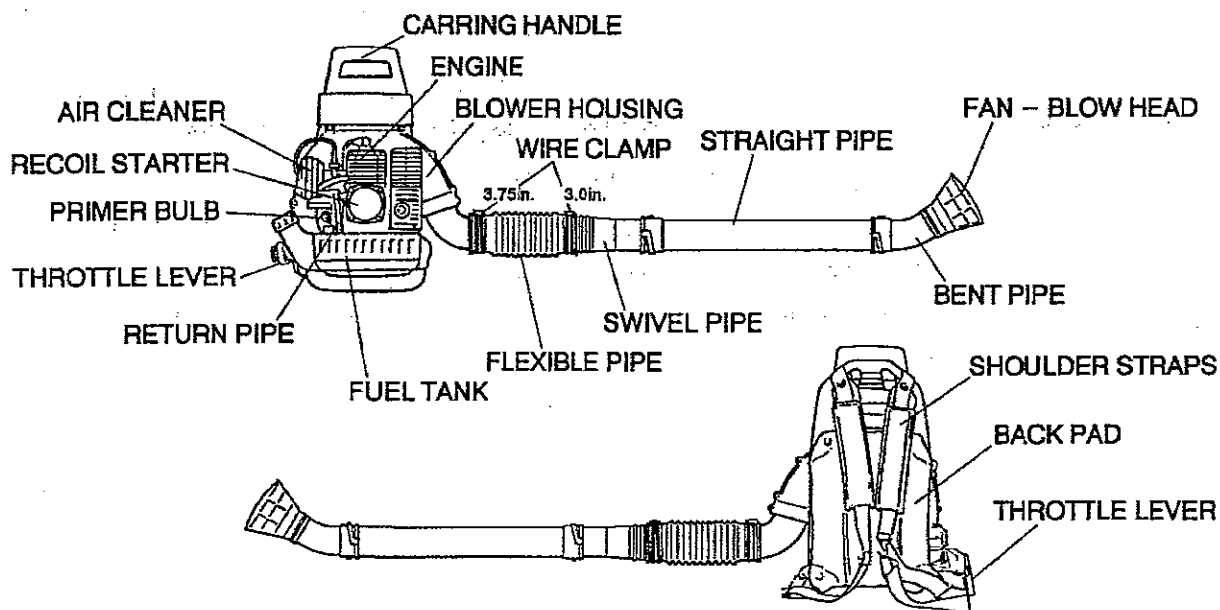

BEFORE OPERATION

Be sure the power blower is correctly assembled and all fasteners and fittings are properly secured.

THROTTLE LEVER

Before operating the power blower, release the knob, rotate the throttle arm to the position in the illustration, and fix the knob.

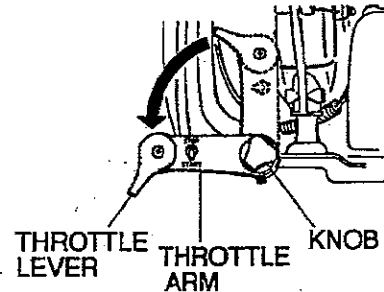

When the power blower is positioned on the back of the operator, the throttle lever is located on the left side of the operator.

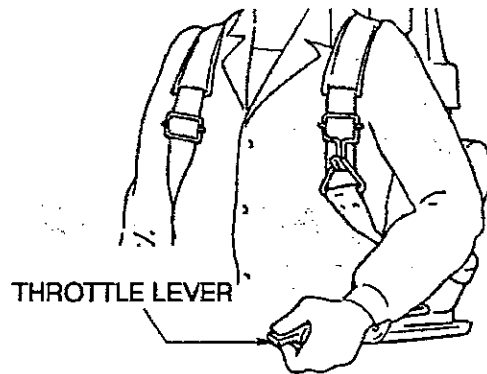

The lowest position of lever is "IDLE" setting, and the highest position is the "FULL THROTTLE" setting.

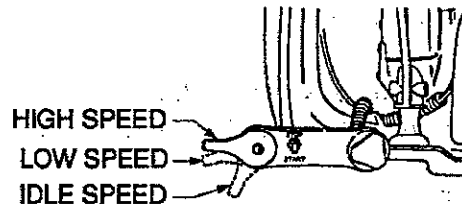

FUEL: MIXING GASOLINE AND OIL

CAUTION! The engine used on this Backpack Blower is of a 2-cycle design. The internal moving parts of the engine, i.e., crankshaft bearings, piston pin bearings and piston to cylinder wall contact surfaces, require oil mixed with the gasoline for lubrication. Failure to add oil to the gasoline or failure to mix oil with the gasoline at the appropriate ratio will cause major engine damage which will void your warranty. For your fuel premix, only use Maruyama 50:1 2-Cycle Oil or a quality oil designed for 2-cycle air cooled engines.

FUEL MIXTURE: When using genuine Maruyama 50:1 2-Cycle Oil, or a quality oil designed for 2-Cycle air-cooled engines, oil ratio is 50 parts gasoline to 1 part oil or 50:1.

FUEL: MIXING GASOLINE AND OIL

CAUTION! If Maruyama oil is not used, never use a mixing ratio less than 50:1 regardless of the oil package mixing instructions. Ratios less than 50:1, (for example, 60:1, 80:1, 100:1), reduce the amount of lubrication to the internal moving parts of the engine and can cause damage.

Gasoline	Maruyama 50:1 2-Cycle Oil
1 gallon	2.6 oz.
2 1/2 gallons	6.4 oz.
5 gallons	12.8 oz.

MIXING INSTRUCTIONS: Always mix fuel and oil in a clean container approved for gasoline. Mark the container to identify it as fuel mix for the Backpack Blower. Use regular unleaded gasoline and fill the container with half the required amount of gasoline. Pour the correct amount of oil into the container then add the remaining amount of gasoline. Close the container tightly and shake it momentarily to evenly mix the oil and the gasoline before filling the fuel tank on the Backpack Blower.

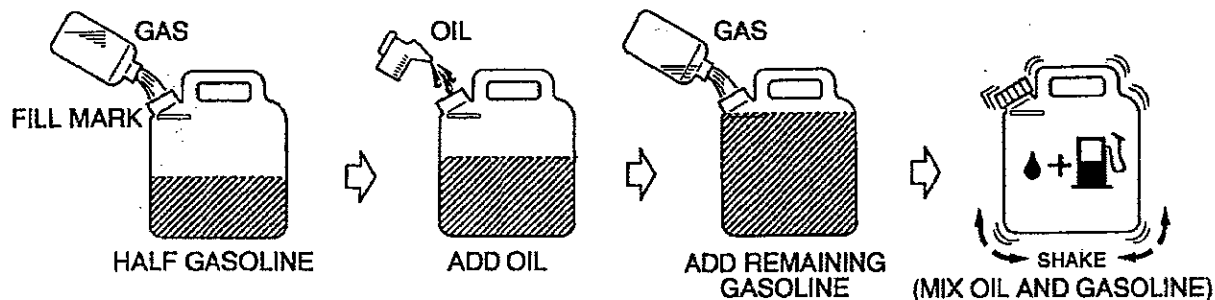

When refilling the Backpack Blower fuel tank, clean around the fuel tank cap to prevent dirt and debris from entering the tank during cap removal. Always shake the premix fuel container momentarily before filling the fuel tank.

Always use a spout or funnel when fueling to reduce fuel spillage. Only fill the tank to within 1/4 – 1/2 inch from the top of the tank. Avoid filling to the top of the tank filler neck.

NOTE:

1. Never mix gasoline and oil directly in the Backpack Blower fuel tank.

CAUTION!

1. Do not use National Marine Manufacturer's Association (NMMA) or BIA certified oils. This type of 2-cycle engine oil does not have the proper additives for air-cooled, 2-cycle engines and can cause engine damage.
2. Do not use automotive motor oil. This type of oil does not have the proper additives for air-cooled, 2-cycle engines and can cause engine damage.

OPERATING INSTRUCTIONS

STARTING PROCEDURE

STEP #1) Pump the "PRIMER BULB" on the side of the carburetor until fuel can be seen flowing through the "FUEL-RETURN LINE".

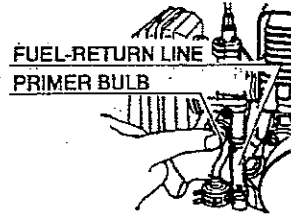

STEP #2) Move the "CHOKE LEVER" fully upward to the closed position. If the engine is already warm, only a partial or open (no choke) choke setting may be required.

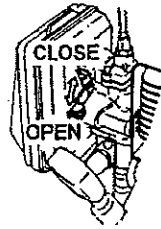

STEP #3) Turn the stop switch ON. (Confirm that the stop switch is at the starting position.)

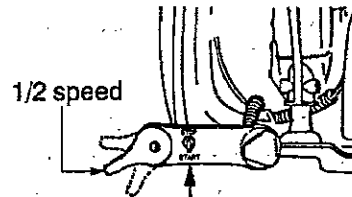

STEP #4) Set the throttle lever at 1/2 speed.

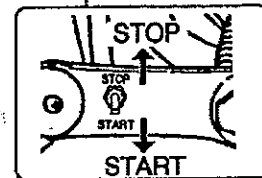

WARNING! Pull the "STARTER GRIP" briskly to start the engine.

NOTE: Only short pulls are necessary. Never pull the starter cord to its fullest extension. Never let go of the starter grip until it is at the fully returned position.

STARTER GRIP

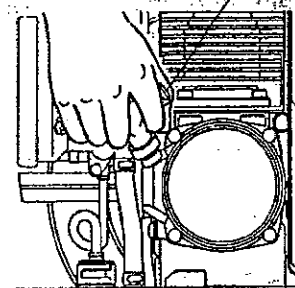

STEP #6) Warming up the engine. When the engine has started, slowly move the "CHOKE LEVER" fully downward to the open position. Allow the engine to "WARM-UP" at less than 1/2 speed.

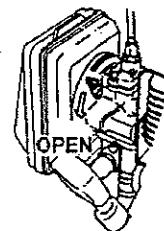

If a MARUYAMA engine fails to start after following the above procedures, contact an authorized MARUYAMA dealer.

BLOWER OPERATION

When the engine has warmed-up, the power blower can be positioned on the back of the operator.

When the power blower is positioned and ready for operation, adjust the throttle to a speed required to accomplish the task.

WARNING!

- Never operate a power blower when you are fatigued.
- Never operate a power blower without proper guards or other protective safety devices in place.

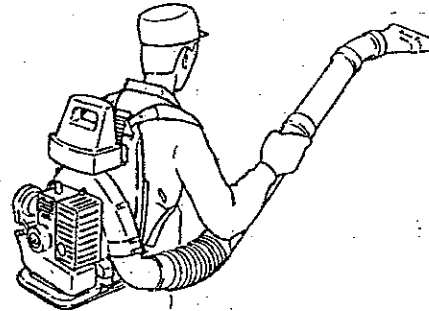

OPERATING POSITION

STOPPING THE ENGINE

Always run the engine at idle speed for a few minutes to allow cooling before stopping. To stop the engine, move the throttle control lever all the way downward to the engine idle position, then move the stop switch to the "STOP" position.

REGULAR MAINTENANCE

Before each use, the power blower should be inspected for proper assembly and fitness of all components. All fasteners should be checked for correct tightness. Always inspect for fuel leaks.

WARNING! Do not attempt to start or operate a power blower that indicates a fuel leak.

AIR FILTER

The air filter should be inspected each time the power blower is used (or more often with extreme conditions).

To inspect, remove the air filter cap. The element is easily pulled from the case.

Clean the element by washing it in kerosene or warm detergent solution. Squeeze it dry. Apply #30wt. oil to the element, removing all excess oil, and install the element.

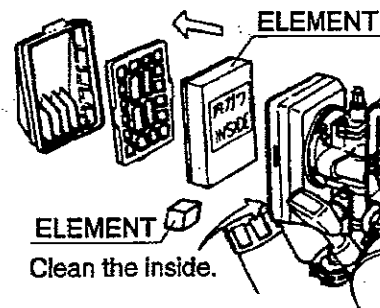

SPARK PLUG

The spark plug should be removed from the engine and checked after each fifty (50) hours of use. The tips can be cleaned with a stiff brush. Adjust the gap to 0.024—0.028 inches (see sketch). Replace the spark plug if it is oil-fouled or damaged.

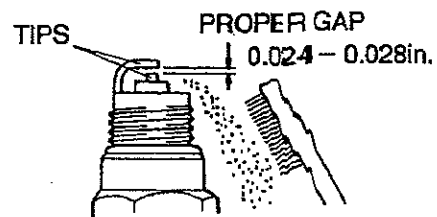

WARNING! The correct torque for the spark plug is 10—12 ft.lbs. Do not over-tighten.

FUEL FILTER

The fuel filter should be cleaned and inspected for damage after each twenty (20) hours of use. The fuel filter is attached to the fuel pickup tube inside the fuel tank. Loosen the clamp and take out the fuel filter.

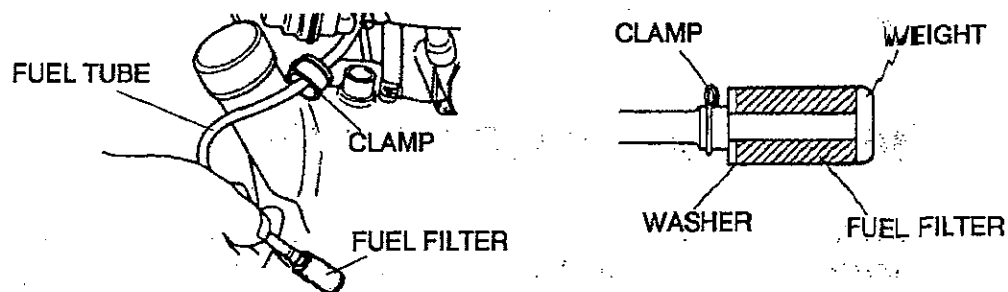

To clean the fuel filter, remove it from the fuel tube and wash it with fuel mixture. Inspect and clean the fuel tank before re-installing the fuel filter. Always replace a defective fuel filter.

COOLING FINS

Free passage of air through the cylinder cooling fins is required to prevent poor engine performance and shortened engine life. Regularly check and clean all debris from the cooling fins by removing the engine cover (see sketch).

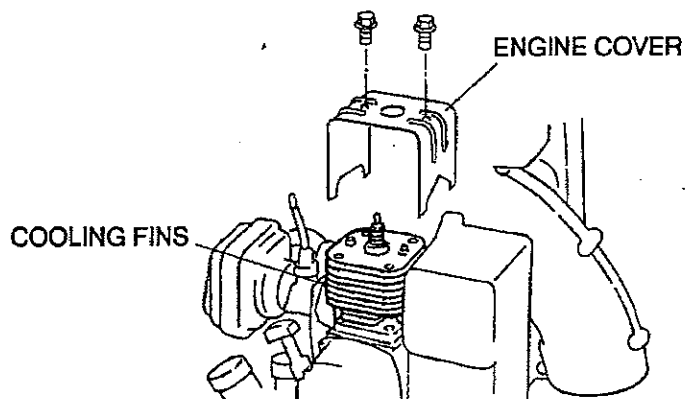

MUFFLER AND EXHAUST PORTS

The muffler should be removed and serviced after each one hundred (100) hours of use. At the same time, the exhaust ports should be cleaned and inspected. An AUTHORIZED MARUYAMA DEALER should be contacted for this service.

GENERAL CLEANING AND TIGHTENING

The MARUYAMA power blower will provide maximum performance for many, many hours if it is maintained properly. Good maintenance includes regular checking of all fasteners for correct tightness, and cleaning the entire machine. Contact an authorized MARUYAMA dealer for additional maintenance suggestions.

STORAGE

For long-term storage of the power blower, first perform all regular maintenance procedures and needed repairs. Empty the fuel tank. Disconnect the fuel-return line from the carburetor, then gently hold the tickler lever down while pumping the primer bulb until fuel stops discharging from the fuel-return fitting.

Start the engine and allow it to run until it stops. Pull the starter cord a few times to remove any excess fuel from the engine. Remove the spark plug and insert a small amount of oil into the cylinder. Slowly pull the starter cord and bring the piston to a position closest to the spark plug hole. Re-install the spark plug. Apply a thin coating of oil to all the metal surfaces and store the power blower in a dry place.

EMISSION CONTROL INFORMATION

FUEL INFORMATION

THIS ENGINE IS CERTIFIED TO OPERATE ON UNLEADED REGULAR GRADE GASOLINE ONLY. A minimum of 87 octane of the antiknock index is recommended. The antiknock index is posted on service station pumps in the U.S.A..

EMISSION CONTROL INFORMATION

To protect the Environment in which we all live, Kawasaki has incorporated exhaust emission control system (EM) in compliance with applicable regulations of the California Air Resources Board.

EXHAUST EMISSION CONTROL SYSTEM(EM)

The exhaust emission control system applied to this engine consists of a carburetor and an ignition system having optimum ignition timing characteristics. The carburetors have been calibrated to provide lean air/fuel mixture characteristics and optimum fuel economy with a suitable air cleaner and exhaust system.

MAINTENANCE AND WARRANTY

Proper maintenance is necessary to ensure that your engine will continue to have low emission levels. This Owner's Manual contains those maintenance recommendations for your engine. Those items identified by the Periodic Maintenance Chart are necessary to ensure compliance with the applicable standards.

The Maruyama Limited Emission Control System Warranty requires that you return your engine to an authorized Maruyama engine Dealer for remedy under warranty. Please read the warranty carefully, and keep it valid by complying with the owner's obligations it contains.

TAMPERING WITH EMISSION CONTROL SYSTEM PROHIBITED

California State law prohibits the following acts or the causing there of: (1) the removal or rendering inoperative by any person other than for purposes of maintenance, repair, or replacement, of any device or element of design incorporated into any new engine for the purposes of emission control prior to its sale or delivery to the ultimate purchaser or while it is in use, or (2) the use of the engine after such device or element of design has been removed or rendered inoperative by any person.

Among those acts presumed to constitute tampering are the acts listed below:

Do not tamper with the original emission related parts:

- Carburetor and internal parts
- Spark Plug
- Magneto or electronic ignition system
- Fuel Filter
- Air cleaner element

TUNE-UP SPECIFICATIONS

ITEM	Specifications	
	TE48MX / LMX	TE40MX / DX
Valve Clearance	Not applicable	
Ignition Timing	Unadjustable	
Idle Mixture	Unadjustable	
High Idle Mixture	Not applicable	
Spark Plug	BM7	
Spark Plug Gap	0.6~1.7mm (0.024~0.028 in.)	
Bore × Stroke	44 × 32 mm	40 × 32 mm
Displacement	48.7 cc	40.2 cc
Other Specifications	No other SPECIFICATION NEEDED	

FUEL RECOMMENDATIONS

FUEL

The Kawasaki TE series 2-stroke engines require a gasoline-oil mixture. Use only clean, fresh, unleaded regular grade gasoline.

Octane Rating

The octane rating of a gasoline is a measure of its resistance to "knocking". Use a minimum of 87 octane of the antiknock index is recommended. The antiknock index is posted on service station pumps in the U.S.A.

NOTE:

- It "knocking or pinging" occurs, use a different brand of gasoline or higher octane rating.

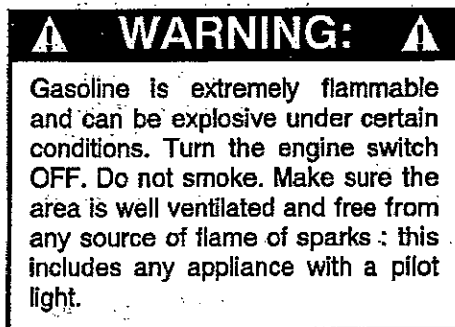

2-STROKE ENGINE OIL MIXING

Oil must be mixed with the gasoline to lubricate the piston, cylinder, crankshaft, bearings, and connecting rod bearings.

Recommended Engine Oil : 2-stroke air cooled brand oil

Gasoline and engine oil mixing ratio : 50 :1 (gasoline 50, 2-stroke Engine Oil 1)

NOTE:

- Do not mix gasoline and oil directly in the fuel tank.
- The lubricative quality of this mixture deteriorates rapidly.
- Do not use gasoline that has been stored longer than two months.
- To ensure proper starting at low ambient temperatures, fresh winter grade fuel must be used.

CAUTION: The engine is shipped without fuel.

ADJUSTMENT

IDLING SPEED ADJUSTMENT

NOTE:

- Do not tamper with the carburetor setting to increase the maximum engine speed, every carburetor is adjusted at the factory and a stop plate is inserted over the high speed mixture screw.
- If adjustment is needed, have it performed by your authorized Kawasaki engine dealer.

MAINTENANCE

PERIODIC MAINTENANCE CHART

▲ WARNING: ▲

Always remove the spark plug cap from spark plug when servicing the engine to prevent accidental starting.

MAINTENANCE	INTERVAL				
	Daily	First 20 hours	Every 20 hours	Every 50 hours	Every 100 hours
Check and replenish fuel	●				
Check for fuel leakage	●				
Check bolts, nuts and screws for looseness and loss	●				
Clean fuel filter			●		
★ Clean air filter element			●		
Tighten bolts and nuts		●		●	
Clean spark plug and adjust electrode gap				●	
★ Remove dust and dirt from cylinder fins				●	
M Remove carbon deposits on piston head and inside cylinder				●	
M Remove carbon deposits in the exhaust pipe of muffler				●	
M Clean net of spark arrester (if equipped)				●	
M Check the sliding portion of crankshaft, connecting rod etc.					●
Fuel tube	It is recommended to replace every 3 years.				

Note: The service intervals indicated are to be used as a guide. Service to be performed more frequently as necessary by operating condition.

M: Service to be performed by an authorized Maruyama engine dealer.

★: Service more frequently under dusty conditions.